



# **PX128/PX136**

PROFESSIONAL SEQUENCE POWER DISTRIBUTOR

# PRECAUTIONS

- Thank you for purchasing our products. Please read this manual carefully for your correct operation of this equipment, and keep this manual for future reference.
  
- For your safety please don't open the rack to avoid electric shock due to high voltage inside. Consult professionals for maintenance help.
- Keep the equipment off rain or humidity.
- This equipment must work in places with good air flow.
- Please check whether local voltage supply can meet the requirement of this equipment.
- Please pull out the plug when this equipment is not in use for a long time.
- Load must be configured following this manual. Don't let the equipment work overloaded for a long time.

 Please make sure the local power supply is similar to what this appliance requires ( AC220V~/50HZ),and carefully check there is no any damage for outlet and wire prior to operating the appliance.

# CONTENTS

## Introduction

- Features ..... 4
- Power cord connection ..... 4
- Front panel function instructions ..... 5
- Back panel function instructions ..... 6

## Installation

- Network connection ..... 7

## Additional Instruction

- FAQ ..... 8
- Safety Regulations ..... 9
- Specifications ..... 10
- Maintenance ..... 10

# INTRODUCTION

Please read this manual carefully before you begin to use this equipment, and keep the manual for future reference.

## FEATURES

---

It's a professional sequence power distributor, which can distribute main power into eight power outputs, and turn on/off every output power sequently, that to effectively reduce the shock to system, specially cater for large sound Reinforcement venue.

- One main power input, six or eight controlled power output
- Built-in processor, turn on clockwise, turn off anti-clockwise, available for network connection, easy operation.
- LED indication for each channel turn on/off
- BYPASS switch and independent switch control for every channel, flexible usage
- Cute and solid shape

## POWER CORD CONNECTION

---

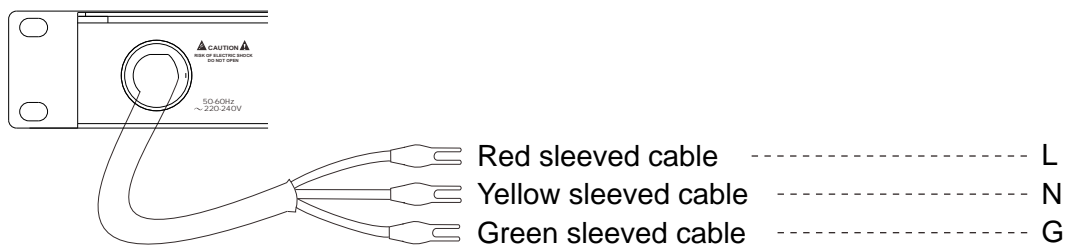

# FUNCTION INSTRUCTIONS

## FRONT PANEL

Take PX128 as example ( PX136 is same as PX128, except for Channel 7 and Channel 8)

**1: Sequent turn on/off LED**

The LED is active, when sequent switch is on.

**2: Sequent switch control**

Press switch, every power channel is connected sequentially

**3: Network connection LED**

The LED is active, when many systems are connected at the same time.

**4: Main power/voltage screen**  
Show main power/voltage

**5: BYPASS switch LED**

Press Bypass switch, Bypass function is activated, and LED is active

**6: Main power switch LED**

Press main power switch, cut off all channels, the LED is active

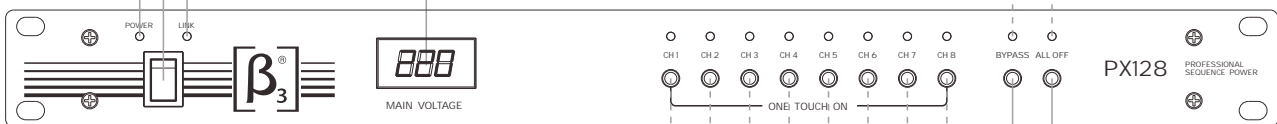

**7:CH1----Switch**

Press the switch can cut off power of this channel independently.

**8:CH2----Switch**

Press the switch can cut off power of this channel independently.

**9:CH3----Switch**

Press the switch can cut off power of this channel independently.

**10:CH4----Switch**

Press the switch can cut off power of this channel independently.

**11:CH5----Switch**

Press the switch can cut off power of this channel independently.

**12:CH6----Switch**

Press the switch can cut off power of this channel independently.

**13:CH7----Switch**

Press the switch can cut off power of this channel independently.

**14:CH8----Switch**

Press the switch can cut off power of this channel independently.

**15: BYPASS switch**

Press this switch, the function of sequent turn on/off is not available, meanwhile switch on all power channels.

**16: Main turn on/off switch**

Press this switch, cut off all channels

# FUNCTION INSTRUCTIONS

## BACK PANEL

Take PX128 as example ( PX136 is the same as PX128, except for Channel 7 and Channel 8)

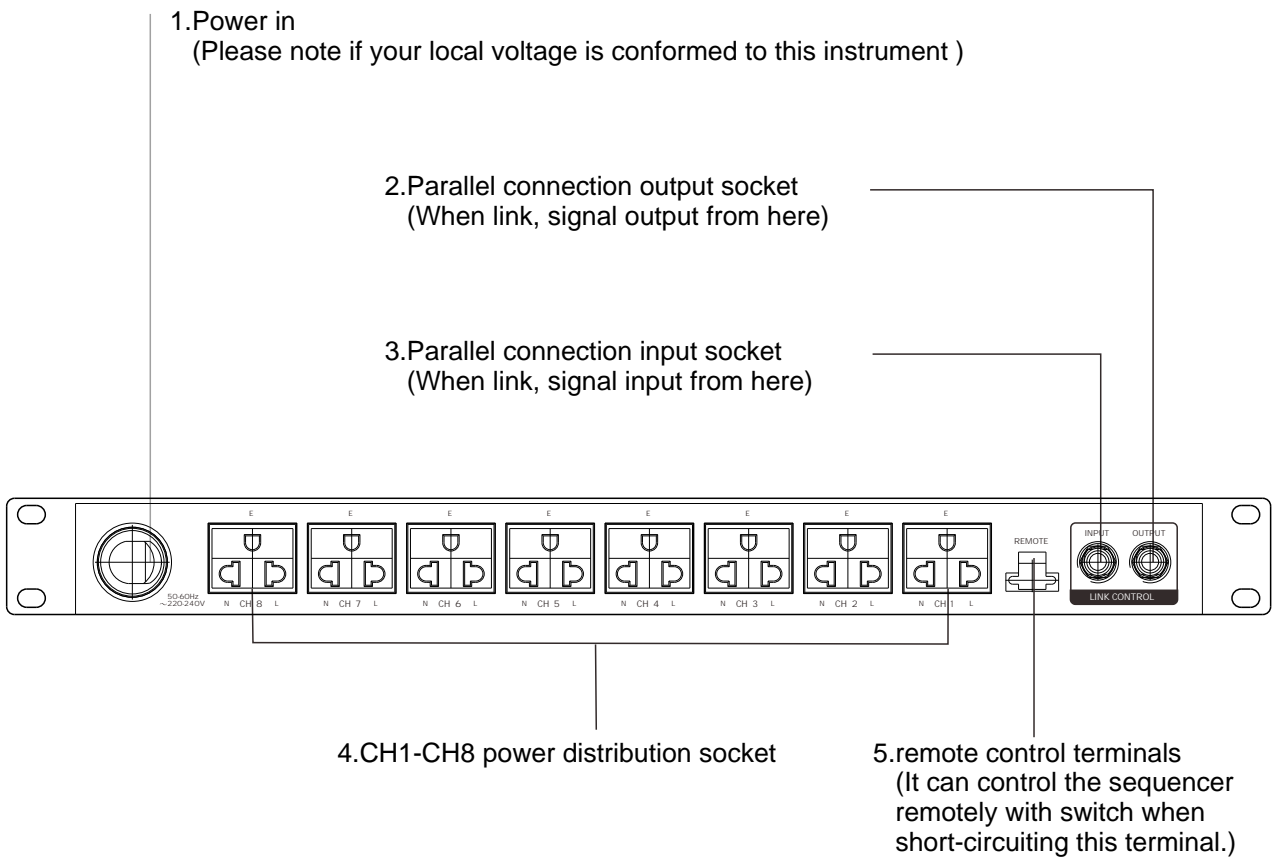

# INSTALLATION

## INSTRUCTION OF PARALLEL CONNECTION CONTROL

### 1> Illustration of Parallel connection

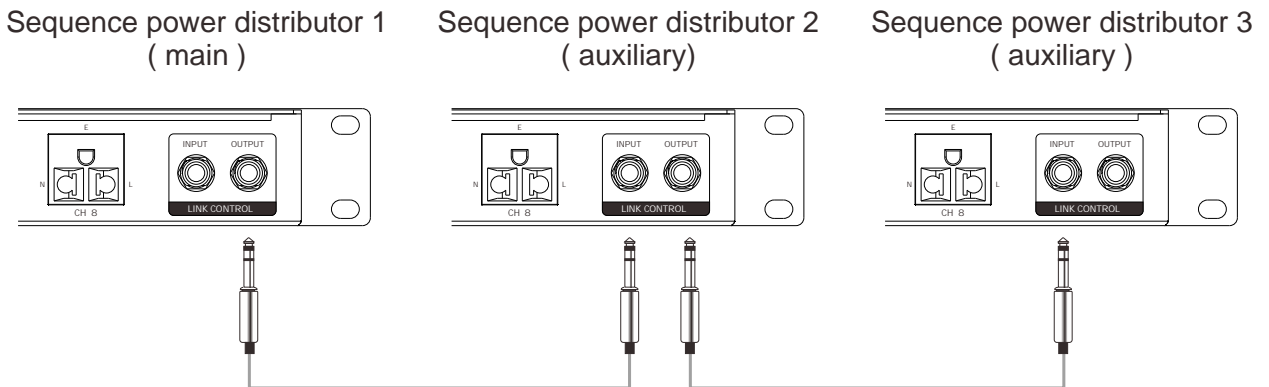

### 2>Remark:

Please turn off all the sequence power distributor when link parallel. After connection, can use the first equipment to control all the sequence power distributor .

### 2>Connection diagram of remote control terminal:

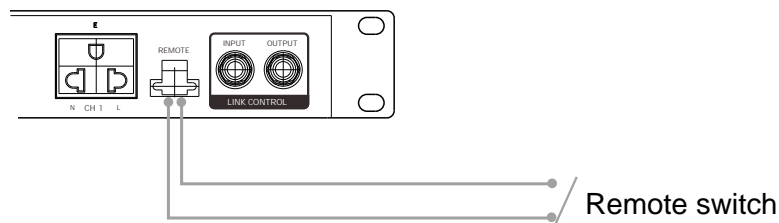

# ADDITIONAL INSTRUCTION

## USUAL FAILURE AND EXCEPTION HANDLES

---

Failure Phenomena	No.	Exception Handles
Power indicated LED doesn't light	1	Check if the equipment plug connect well with the power supply
	2	Check if the power supply have the right voltage
Cannot be connected parallel	1	Make sure to connect the link control line before power on
	2	Check if the link connection is right and well
Others	1	Please check the equipment settings and linking by instruction
	2	Please consult with your local specialist or browse our website: <a href="http://www.elderaudio.com">http://www.elderaudio.com</a>

Please consult professional personnel for help if the aboven-mentioned operation does not work efficiently.



# ADDITIONAL INSTRUCTION

## SAFETY INSTRUCTIONS

---

### DO NOT OPEN THE COVER :

Do not open the cover to avoid the risk of electric shock caused by high voltage parts in the product. Any problems caused by user's wrong actions are out of warranty.

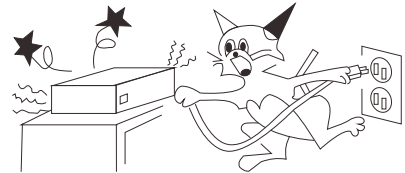

### DO NOT DAMAGE THE POWER CORD :

Please hold the plug when pull out or plugging the cord. Do not pull out or touch the cord with wet hand, or it will cause the risk of electric shock. Power supply cords should be routed so they are not likely to be walked upon or pinched by items placed on or against them. When removing the cord from a power outlet be sure to remove it by holding the plug attachment and not by pulling on the cord.

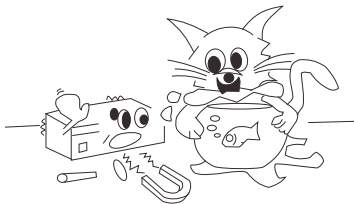

### AVOID OBJECT AND LIQUID ENTRY :

Take care that objects do not fall into and that liquids are not spilled into the inside of the product . If the object or liquid enter the product , please ask qualified personnel to check it.

### ABNORMAL STATUS :

In the event of abnormal noise and smell, please put off the power supply and pull out the cord, please ask qualified personnel to check it.



### NONUSE FOR A LONG TIME :

When nonuse it for a long time, please put off the power supply and pull out the cord to avoid the unexpected dangers.

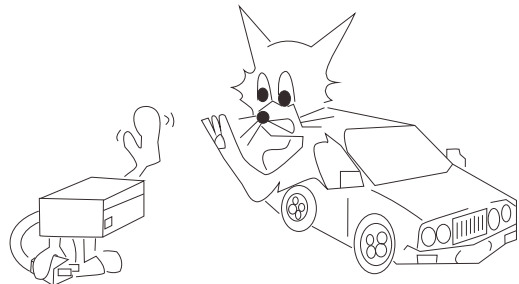

# ADDITIONAL INSTRUCTION

## SPECIFICATION

---

	PX128	PX136
Total Max. Output (RMS)	16KW	18KW
Per Channel Max. Output (RMS)	2KW	3KW
Sequence Delay Time	1s	1s
Parallel Connection	available	available
Bypass Function	available	available
Voltage	220V 50Hz/60Hz	220V 50Hz/60Hz
N.W.	5Kg	5Kg
G.W.	6Kg	6Kg
Dimension (WxHxD)	484*222*44.5 mm	484*222*44.5 mm
Packing ( WxHxD )	555*310*78mm	555*310*78mm
User Manual	One	One

Parameters Subject To Change Without Notice

## MAINTENANCE

---

- ▲ The equipment can be cleaned with dry cotton cloth. If the equipment is abnormally dirty, please clean it with a piece of cotton cloth dipped in detergent for 5 to 6 seconds, and finally dry it with a piece of dry cloth.
- ▲ Don't use alcohol, insecticide, or any other volatile or corrosive liquid to clean the equipment, which will cause colour fade or flake-off of the equipment surface.
- ▲ When the equipment is not used for a long time, please keep it in an appropriate dry place.



**PX128/PX136**