

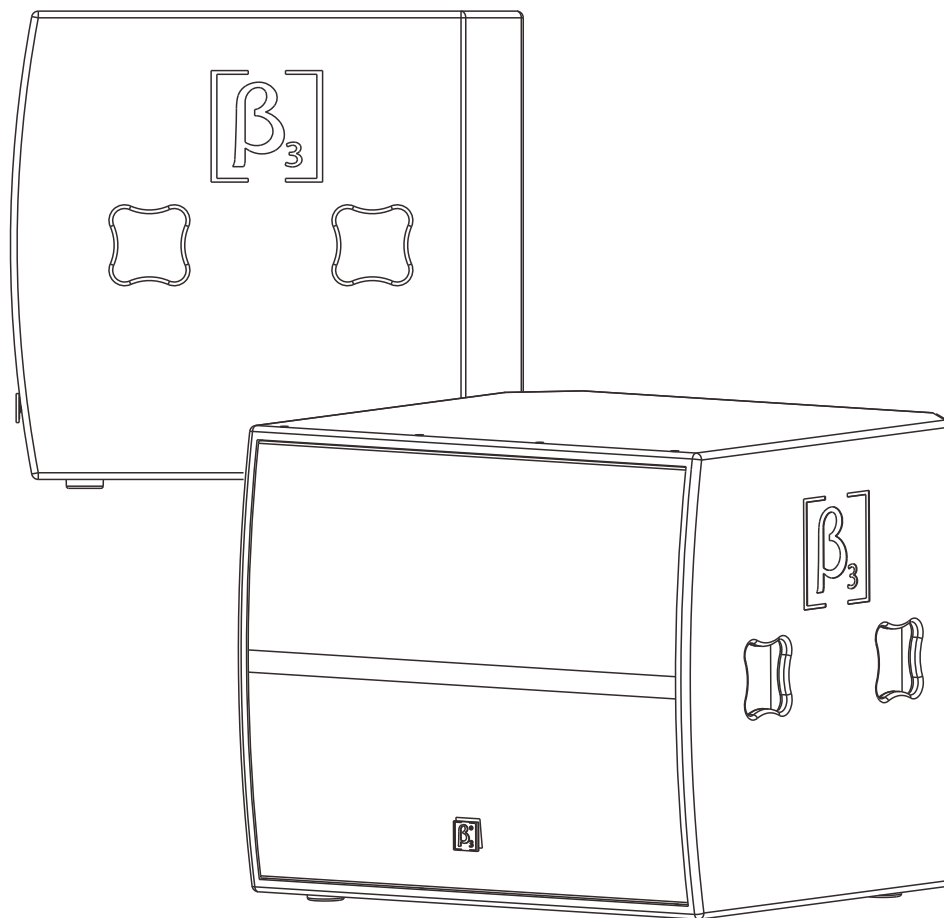

Beta Three



X18Bi  
18"Subwoofer

User Manual





UM-X18Bi-20120217 ver A



# SAFETY INSTRUCTIONS

## PLEASE READ THIS MANUAL FIRST

Thank you for a buying  $\beta_3$  product. Read this manual first as it will help you operate the system properly. Please keep this manual for future reference.

**⚠ WARNING:** *This product must be installed by professionals. When using hanging brackets or rigging other than those supplied with the product, please ensure they comply with the local safety codes.*

	<b>CAUTION</b> RISK OF ELECTRICAL SHOCK DO NOT OPEN	
CAUTION: TO REDUCE THE RISK OF ELECTRIC SHOCK, DO NOT REMOVE COVER (OR BACK). NO USER-SERVICABLE PARTS INSIDE. REFER SERVICING TO QUALIFIED PERSONNEL.		

	<b>AVIS</b> RISQUE DE CHOC ÉLECTRIQUE NE PAS OUVRIR	
ATTENTION : POUR RÉDUIRE LE RISQUE DE DÉCHARGE ÉLECTRIQUE, NE RETIREZ PAS LE COUVERCLE (OU L'ARRIÈRE). IL NE SE TROUVE À L'INTÉRIEUR AUCUNE PIÈCE POUVANT ÊTRE RÉPARÉE PAR L'USAGER. S'ADRESSER À UN RÉPARATEUR COMPÉTENT.		

 *The exclamation point within an equilateral triangle is intended to alert you to the presence of important operating and servicing instructions.*

**⚠ ATTENTION:** *Don't refit the system or spare parts without being authorized as this will void the warranty.*

**⚠ WARNING:** *Don't place naked flames (such as candles) close to the equipment.*

1. Read the instruction manual first before using this product.
2. Please keep this manual for future reference
3. Pay attention to all warnings.
4. Obey all operating instructions.
5. Do not expose this product to rain or moisture.
6. Clean this equipment with a dry cloth.
7. Do not block any ventilation openings. Install according to manufacturer's instructions .
8. Do not install this product near any heat source, such as a, heater, burner, or any other equipment with heat radiation .
9. Only use spare parts supplied by the manufacturer.
10. Pay attention to the safety symbol on the outside of the cover.



CONTENT

INTRODUCTION	3
Features	3
Description	3
Applications	3
CONNECTION	4
Speakon	4
NL4 Connection	4
System Connection Reference	4
INSTALLATION	5
TECHNICAL SPECIFICATION	6
Technical Sheet	6
Frequency Response And Impedance Curve	6
2D Dimension	7

## X18Bi

18"Subwoofer

### Features

- Single 18" phase inverted subwoofer.
- Computer aided design to optimize frequency and phase response.
- Frequency response range: 36Hz - 2kHz (-3dB).
- Sensitivity 97dB, MAX.SPL 121dB/127dB (PEAK).
- Rated power 500W, 2000W (PEAK).

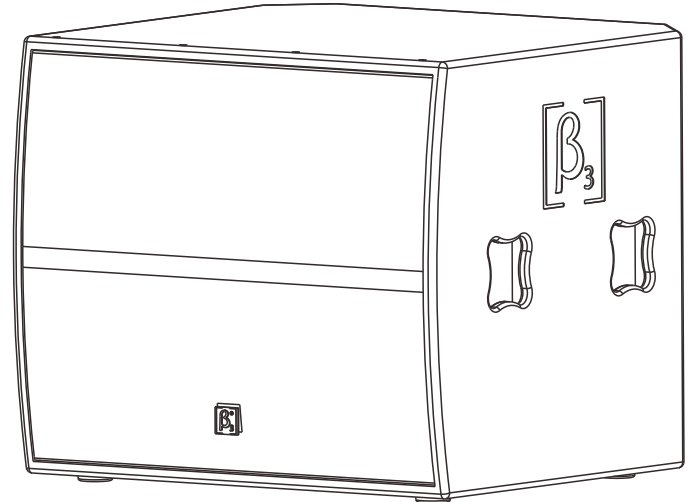

### Description

X18Bi is a compact low frequency speaker system applied to small and medium-sized spaces that require high reliability. Arrayed with X8i and X12i full range speakers to form a high-performance full-range system.

X18Bi adopts a 18-inch woofer, which achieves a fast transient response. The low-frequency driver uses 100mm high power voice coil rounded with copper wire inside and outside. The voice coil skeleton is made of high-strength TIL materials to make voice coil more strengthful and power handling. The RMS is 500W, short-term maximum power can be 2000W(GB/T9396-1996 standard). Symmetrical magnetic circuit design makes odd harmonic distortion much lower, which fully satisfied the requirement of low-frequency sound. Equipped with XC2.6 professional speaker controller can be realized modular quick adjustments.

X18Bi adopts multifunctional structure design that is suitable for touring or fixed installation. The cabinet is made of wood laminate with Polyurethane spray processing to have superior weather resistance. X18Bi can be fast and reliably installed under different environments.

### Applications

- Bars and Dancing halls
- Night Clubs
- Touring
- Clubs

Two NL4 connectors are available for amplifier connections. Paralleled connector is very convenient for another speaker connection.

Terminal Plate

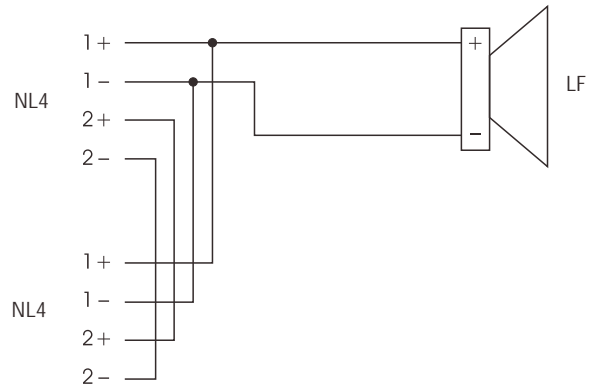
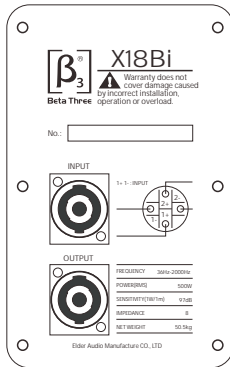

NL4 Connection

1. Connect

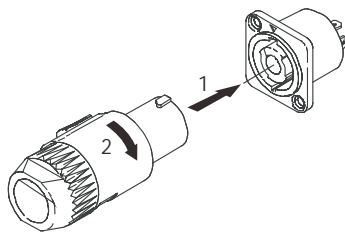

2. Disconnect

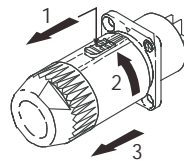

System Connection Reference

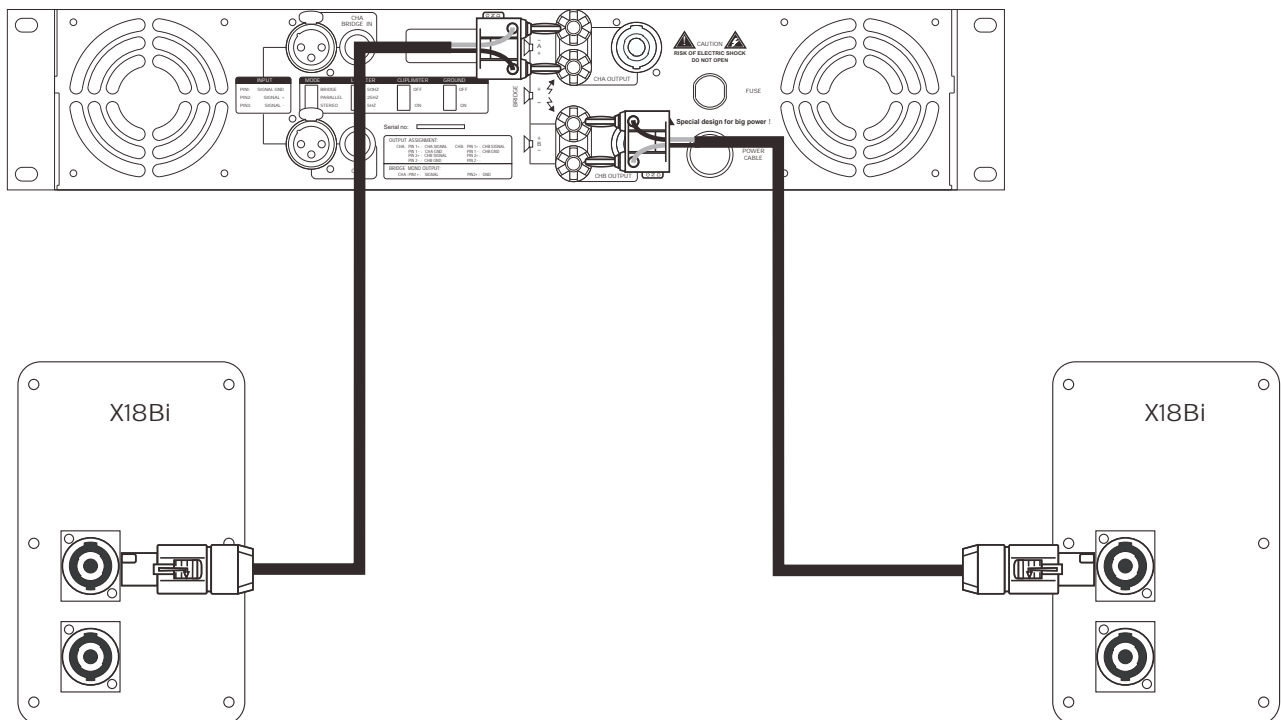

- ⚠ Attention: The impedance of connected speaker must match the impedance of amplifier output.
- ⚠ Attention: Make sure the polarity of speaker and amplifier correctly.

Installation Reference

 **Warning:** Make sure the mounting accessories safety factor not less than 5:1 or meet the local standard during installation .

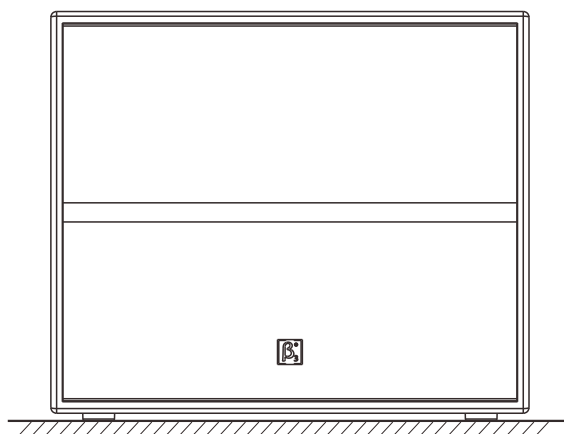

Technical Sheet

System:	Passive full range wooden speaker
System components:	1 x 18 "LF
Frequency response(-3dB): <sup>1</sup>	36Hz-2kHz
Sensitivity(1W@1m): <sup>2</sup>	97dB
Max.SPL(1m): <sup>3</sup>	121dB/127dB(PEAK)
Power:	500W (RMS) <sup>4</sup> 1000W (MUSIC) 2000W (PEAK )
Rated impedance:	8 Ohms
Handle:	4 x Wooden handles
Painting:	Cabinet coated by Polyurethane paint;grille is powder coated
Connector:	NI4 x 2
Cabinet dimension: (W x D x H)	750 x 690 x 630mm (29.5 x 27.2 x 24.8in)
Package dimension: (W x D x H)	880 x 800 x 775mm (34.6 x 31.5 x 30.5in)
N.W.(pc):	50.5kg(111.1 lbs)
G.W.(pc):	54.5kg(119.9 lbs)

Speaker Testing Method

1. Frequency response

Use Pink noise to test the speaker in the anechoic room, adjust the level to make the speaker work at its rated impedance and the power output is 1W, then test the frequency response 1m away from the speaker.

2. Sensitivity

Use full range Pink noise which was modified by EQ curve to test the speaker in the anechoic room, enlarge the signal to make the speaker work at its rated impedance and the power output is 1W, then test the sensitivity 1m away from the speaker.

3. MAX.SPL

Use full range Pink noise which was modified by EQ curve to test the speaker in the anechoic room, enlarge the signal to make the speaker work at its instant power output level, then test the SPL 1m away from the speaker.

4. Rated Power

Use the pink noise according to IEC#268-5 to test the speaker, enlarge the signal for continuous 100hours, the rated Power is the power when the speaker will not incur hot damage or mechanics damage.

Frequency Response And Impedance Curve

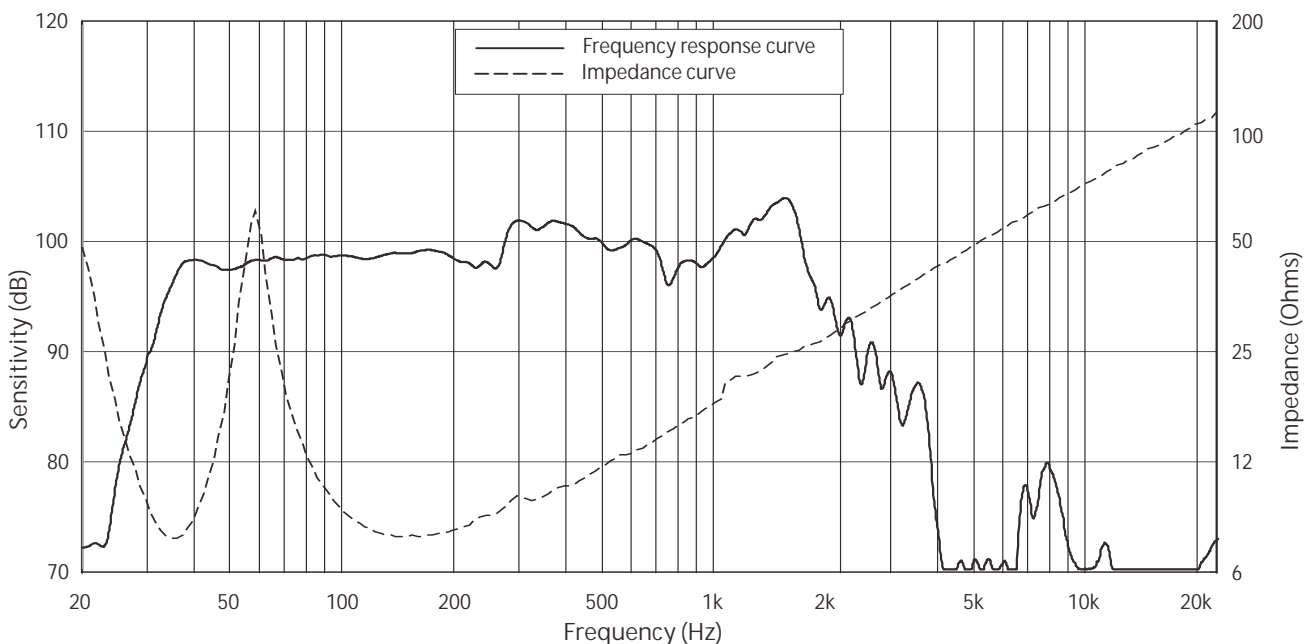

## 2D Dimension

Top view

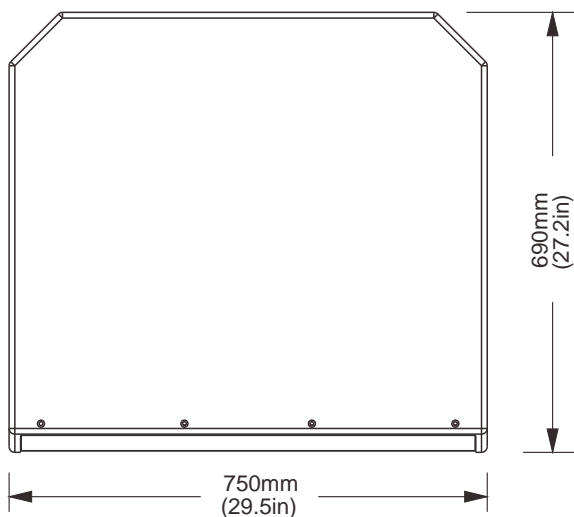

Front view

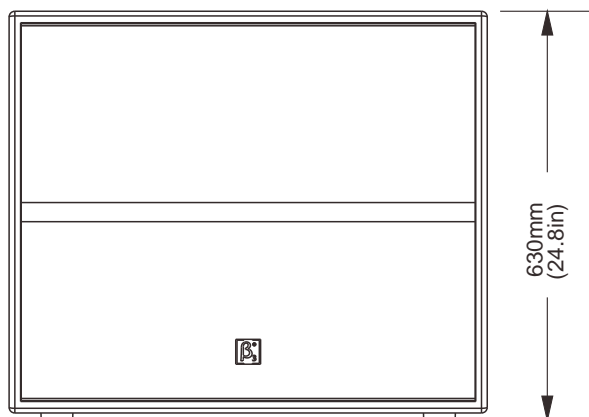

Side view

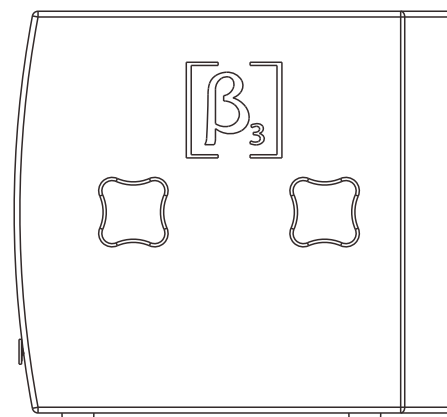

Back view

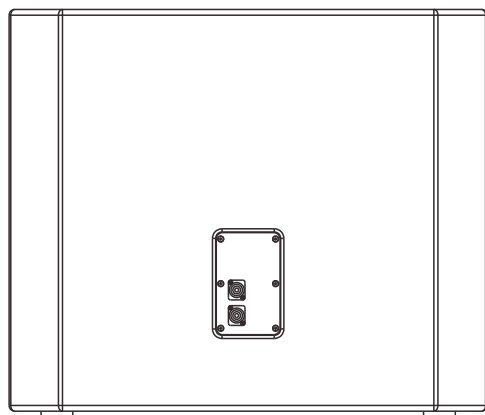



Notes:



**Beta Three**