

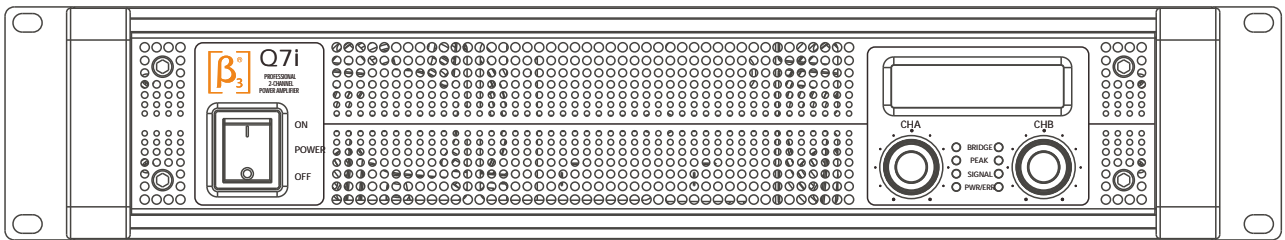

Beta Three

Q series

Two Channel professional power amplifier



NOTE

- ⚠ High voltage inside the equipment, do not open the chassis.
- ⚠ Do not expose the equipment to the rain or moisture.
- ⚠ Keep adequate ventilation, do not block the port.
- ⚠ Be sure the voltage of this equipment complies with the local industrial voltage.
- ⚠ Put off the power plug if not used for long time.
- ⚠ Do not work on overload for long time.

■ Symbols :

- The equilateral triangle with lightning bolt warns the user of dangerous voltage levels localized within the cabinet.
- The equilateral triangle with exclamatory mark means the important operation in the user's manual.

CATALOGUE

1、 Introduction	P1
2、 Parameters	P2
3、 Installation	P4
4、 Front panel	P5
5、 Indicators on front panel	P5
6、 Front panel	P6
7、 Rear panel	P8
8、 Power supply	P8
9、 Input/output connectors	P9
10、 Function setup and cable connection	P10
11、 Operations	P11
12、 Software instruction	P11
13、 USB driver instruction	P22
14、 Protection and the cooling system function	P22
15、 Troubles and trouble shootings	P23
16、 Safety attentions	P24

1.INTRODUCTION

Thanks for your trust and support.

The Beta Three Q Series is new designed professional high power out Class D with DSP solution amplifier.

Q Series professional amplifier adopts high efficiency Class D and switching power supply under 2U equipment cabinet with outstanding radiating solution. The weight can be decreased under 9kg with continuous stability

Q Series professional amplifier adopts DSP audio processor with control of frequency response, crossover point, crossover slop, delay and protection for two channels. it can be preset customized frequency curve.

Product features:

- 1,High power with light weight and easy to use or install.
- 2,Built-in DSP for the most flexible use with different speaker.
- 3,Simple front panel controls and LCD screen give you all control information.
- 4,Accurate temperature protection will make sure the safe working mode.

2.Parameter

Model		Q3i	Q5i	Q7i
Power output (dynamic)	Stereo & parallel Mode(8)	550W/CH	850W/CH	1500W/CH
	Stereo & parallel Mode(4)	1000W/CH	1550W/CH	2500W/CH
	Stereo & parallel Mode(2)	1500W/CH	2500W/CH	3500W/CH
	Bridged mono Mode(8)	2000W	3000W	5000W
	Bridged mono Mode(4)	3000W	5000W	7000W
Power output under limited		300W/CH	500W/CH	700W/CH
Distortion(typical) 1 KHz at full rated power		<0.5%		
Signal to Noise(A-weighted)		>100dB (1kHz, A wight)		
Input Sensitivity		1Vrms		
Maximum Input Level		4Vrms		
Output Circuitry		Class D		
Peak output voltage		100V(per channel) 200V(bridged)	130V(per channel) 260V(bridged)	170V(per channel) 340V(bridged)
Votage gain(8)		37dB	39dB	41.5dB
Standard consumption current 1/8/power(2)		4.5A	6.7A	9.2A
Max consumption current 1/3/power(2)		10A	15.5A	20.5A
Frequency Response(8)		20Hz~20kHz(± 0.5dB)		
Damping factor		>200:1100(Hz)		
Input Impedance()		20k(balanced), 10k(unbalanced)		
Input Port		3-pin XLR		
Output Port		NI4, binding posts		
Power Supply		~ 220-230V 50/60Hz		
Net weight		8.2kg	8.5kg	9.5kg

2.Parameter

Dimension	3.5"(2 RU) × 19" × 12.3"(89mm × 483mm × 310mm)
Packing dimension	125 × 545 × 405mm
Protect Function	Short circuit,open circuit,thermal,RF Protection Load protected against DC faults
DSP Functions	High Pass Filter, adjustable Frequency 20Hz to 20khz Low pass Filter, adjustable Frequency 20Hz to 20khz 8-band PEQ,with variable Frequency,Gain,and Bandwidth limit: compression ratio,bytes,start and recovery time adjustable Delay:9.4167ms(max)can be stored 50 group frequency curve

3.Installation drawing

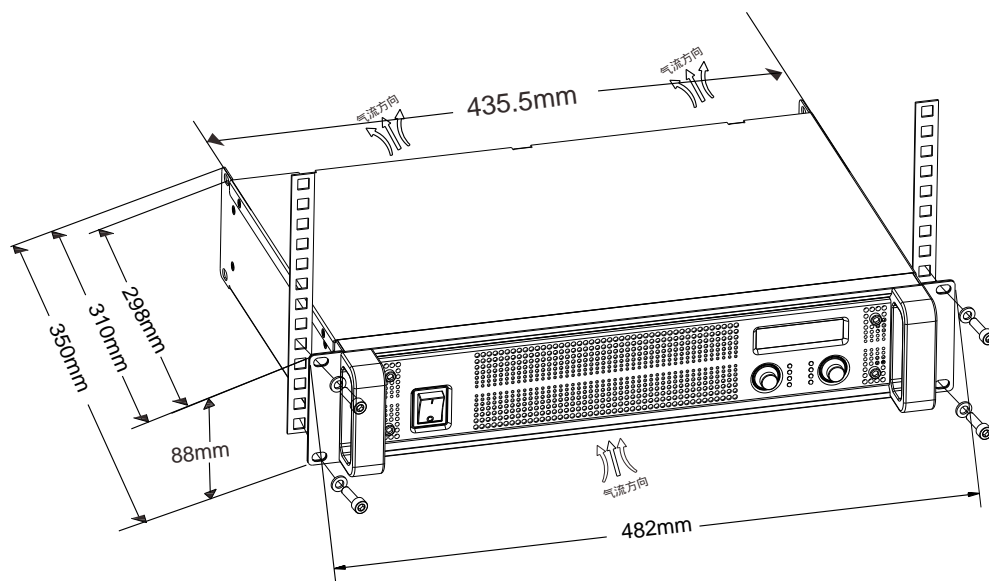
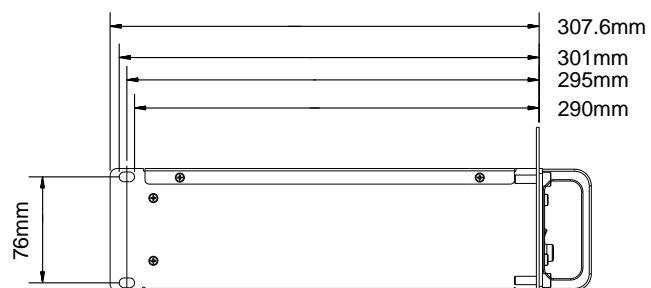

4. FRONT PANEL

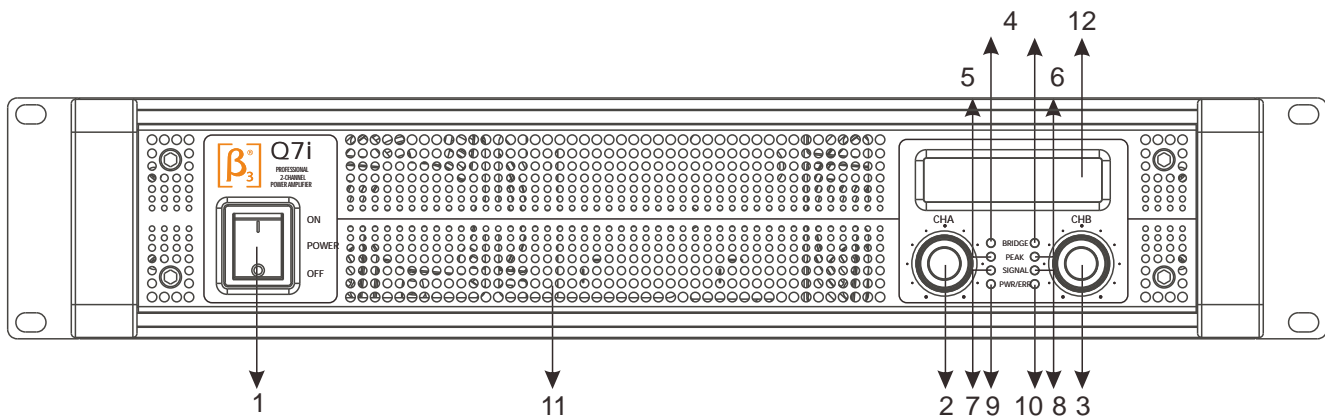

- | | | |
|------------------------------|--------------------------|----------------------------------|
| 1 . Power switch | 5 . Channel-A peak led | 9 . Channel-A PWR/ERR indicator |
| 2 . Channel-A gain knob | 6 . Channel-B peak led | 10 . Channel-B PWR/ERR indicator |
| 3 . Channel-B gain knob | 7 . Channel-A signal led | 11 . Ventilation hole |
| 4 . Channel bridge indicator | 8 . Channel-B signal led | 12 . LED display |

5. INDEICATORS ON FRONT PANEL

PWR/ERR indicator for each separated channels, more indicates as below:

- a . PWR/ERR lights up red when the amplifier is powered on during self-examine process.
This process will not have any output after 5S self-examination, PWR/ERR lights turn green.
- b . PWR/ERR lights flashing when the amplifier is short circuit or at too low impedance, however it can be a green light by turn off volume .Please check the loading impedance and output connection.
- c . PWR/ERR lights red when device temperature is over the limit and output is temporarily cut off.
Please turn off the amplifier, improve the cooling condition and clean the ventilation.
- d . PWR/ERR lights continuous red when power supply voltage too high or too low, please use the correct one. In this situation, the amplifier can get back to normal work when power disconnects 3 minutes or more.
- e . PWR/ERR lights red when defection appears, if you are not sure the problems, please consult technicians.

SIGNAL output indicator for each separated channel.

SIGNAL signal indicator is equivalent to outputs paralleled on the circuit. When the Gain is turned to minimum and whether there is input signal, the signal indicator will not light up.

CLIP output clipping indicator for each separated channel.

When input signal is too big, the CLIP indicator lights up. Too strong and continuous clip may cause damage to the speaker and sound. Please reduce gain or signal input when the clip is too frequent.

BRIDGE indicator, it's switched to bridge mode, means two channels are bridged.

6. FRONT PANEL CONTROL INSTRUCTIONS

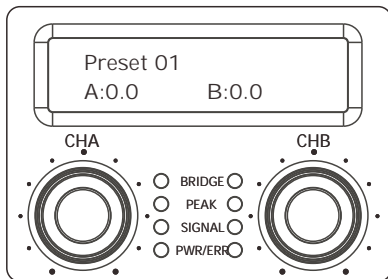

Remark: When amplifier PWR/ERR become red or connected with PC, the two knobs on front panel is no function.

A: CHA knob is to select the parameter, CHB knob is to change the parameter and confirm.

When power on, enter to main menu automatically. Press CHA to enter parameter selection menu screen, the follow instructions are based on menu order list.

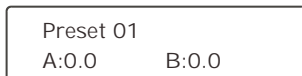

B. For above menu, use CHA and CHB knob to adjust the channel volume, max volume is 0dB.

CHA HPF Freq:
20Hz

C. CHA HPF menu, through CHB knob to adjust HPF crossover point, the range is 20Hz-20 KHz, OFF means close filter and select relevant slope through PC software.

CHA LPF Freq:
OFF

D. CHA LPF menu, through CHB knob to adjust HPF crossover point, the range is 20Hz-20 KHz, OFF means close filter and select relevant slope through PC software.

CHB HPF Freq:
OFF

E. CHB HPF menu, through CHB knob to adjust HPF crossover point, the range is 20Hz-20 KHz, OFF means close filter and select relevant slope through PC software.

CHB LPF Freq:
OFF

F. CHB LPF menu, through CHB knob to adjust HPF crossover point, the range is 20Hz-20 KHz, OFF means close filter and select relevant slope through PC software.

Save as:
Preset 01 No

G. Parameter save menu, save current parameter as Preset one, can recall the preset for next power on; maximum store 50 presets for this device. Also can be saved and named by relevant PC software, through CHB knob to select “ Yes ” or “ NO ” to determine the saving or not, press CHB knob to save.

Preset Recall:01
.....

H. Preset/recall the curve
Press CHA knob for 3 seconds in main menu, shown as above, through CHB knob to select relevant presets; Press CHB knob to confirm to recall the presets, if successful, the recall curve will be shown on screen. Press CHA knob to return main menu and cancel the curve recall.

Remark: When selected curve as below, it means this file doesn't include parameter.

Preset Recall:01
Not Use

7. REAR PANEL

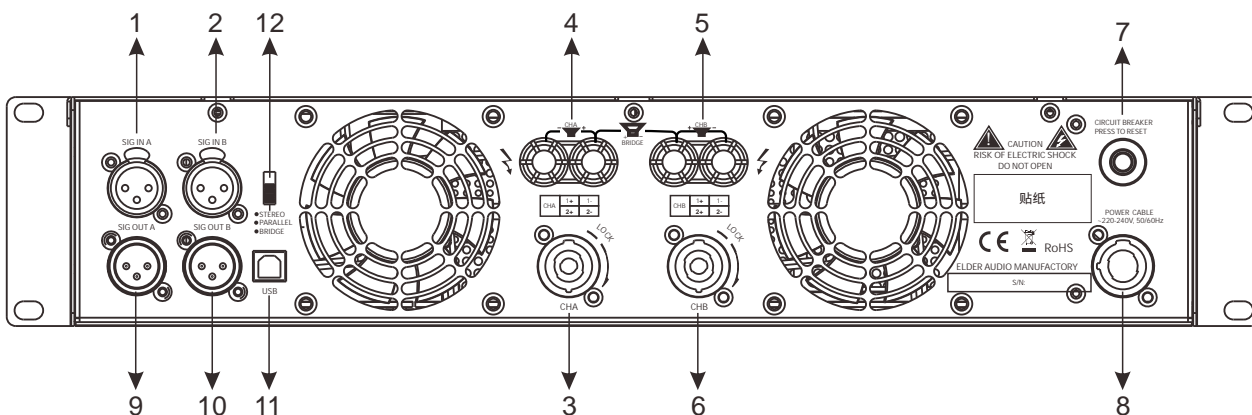

- | | |
|--|----------------------------------|
| 1 Channel-A signal input(XLR) | 7 Switch for link or normal mode |
| 2 Channel-B signal input (XLR) | 8 Power cord |
| 3 Channel-A signal output (NI4) | 9 Channel-A signal output (XLR) |
| 4 Channel-A signal output (binding post) | 10 Channel-B signal output (XLR) |
| 5 Channel-B signal output (binding post) | 11 USB socket |
| 6 Channel-B signal output (NI4) | 12 Modes select switch |

8. POWER SUPPLY

- ⚠ Make sure the local voltage complies with the voltage requirement indicated at the back of amplifier.
- ⚠ Make sure the power cord and socket are good, the plug type matches the sockets.
- ⚠ Make sure the amplifier is well connected to earth.
- ⚠ Pull out plug after power off.
- ⚠ Select the power volume based on power consumption indicated in the date sheet.
- ⚠ Power input of this series amplifier apply circuit breaker replacing blown fuses. To avoid inconvenience of changing fuse, please reset circuit breaker if the amplifier shut down. If this happens again, it indicates the amplifier need servicing.

9. INPUT/OUTPUT CONNECTORS

■ Input connectors

The product is designed with balanced input circuit to lower noise, please use balanced connection for the device.

- ⚠ Note: If your signal output device is an unbalanced circuit design, please do not use single core shielded wire, connect the negative pole of dual core wire to earth and make balanced input connection to get equivalent noise restrain.

Each channel has XLR output and input jack socket with inside parallel connection.

Input jacks of two channels are paralleled directly in parallel mode. Choose any jack to input signal and output from any jack for connecting to next amplifier. But too much cascade connection will cause signal interference and distortion.

- ⚠ Note: please do not input signal from the two input jacks at same time under parallel mode.

■ Output connectors

Each channel have a group of binding posts and one NL4 MP jack for power output, which is paralleled inside.

The red binding post connects to positive pole of power output and the black connect to earth. Under the bridge mode the red binding post of channel A connects to positive pole of output, and the red binding post of channel B connects to negative pole.

Pins 1+, 2+ of NL4 for each channel are connected to positive pole. Pins 1-, 2- are connected to earth. In this way speaker are connected smartly to speaker.

- ⚠ Note: please make sure the speakers impedance connected to each channel not less than 2 (bridge 4), or it may cause power amplifier working abnormally or overheat.
- ⚠ Note: Please power off before connecting and do not touch bare wire in working condition to avoid electric shock.

10.FUNCTION SETUP

Mode option and signal cable connection as the right drawing:

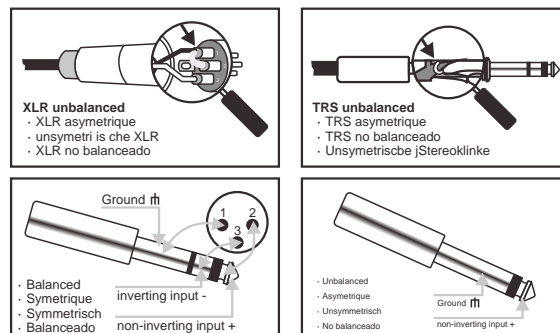

- ⚠** All the input / output sockets and binding posts are located on the back panel, please consult professional to connect cable. There is high voltage from output terminal when the device is working, be aware of electric shock and make sure power is off before connecting cable. Manufacturer shall not be responsible for any kind of device damage or human injuries caused by incorrect operation.

A. Stereo mode:

Set the switch to stereo mode as in the right picture: Under the stereo mode, the signal on CHA and CHB is independent, the signal to channel A is only for channel A, the signal to channel B is only for channel B. Like the right drawing:

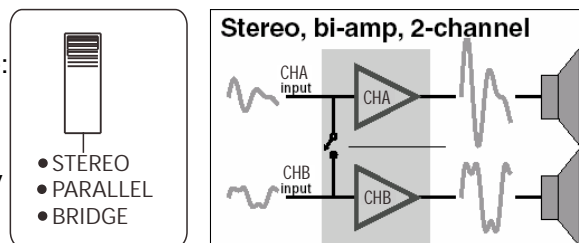

B. Mono mode:

Set the switch to PARALLEL mode, as in the right picture: Under the mono parallel mode, the signal to channel A or channel B is the same. This signal is provided to output A as well as to output B.

- ⚠** Note: please do not input signal to channel A and B at the same time.

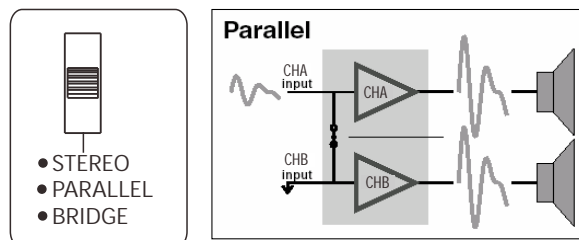

C. Bridge mode:

Set the switch to BRIDGE mode, like in the right picture: Under the bridge mode, there is signal only from channel A, no signal from channel B. The positive (+) of Channel A output is the positive (+) of bridge output, the positive (+) of Channel B output is the negative (-) of bridge output, like

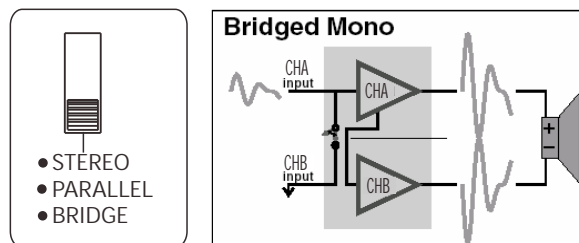

- ⚠** Under the bridge mode, the output voltage is so high enough to make an electric shock. Please power off the unit before operating it under bridge mode.

- ⚠** Under the bridge mode, do not input the signal by channel B and check all the wiring, ensure the input and output line isolation.

11. Operation Procedures

Please refer to following steps:

1> Start

- a setup the function and connection according to the above functions connecting;
- b Check if the output cable is short circuit or working at wrong load impedance;
- c Check if the local voltage complies with the user's manual;
- d Be sure the equipment is power off and the volume knob is to the minimum;
- e Connect the power supply, turn on the device of sound source and other related devices and make sure these equipment work in order;
- f Turn on the power switch
- g Adjust the knob of volume clockwise to a suitable level

2> Power off

- a Turn the volume knob to the minimum
- b Turn off the power switch
- c Turn off other related devices

12. SOFTWARE INSTRUCTIONS

A. How to get our software

The software is stored in the CD with equipment packaging. The latest version also may be downloaded from our website.

B. Software installation

System requirement: Microsoft Windows98XP or above version. Display resolution should be 800*600 or above. The computer must have one USB port. Run the only file in CD according the setup guide to install this software.

C. Equipment connection

Connect the equipment directly to computer or by USB port, after then, the computer will indicate that new device is found, you can install the USB driver located in " driver " directly of the CD.

D. Software use

1 > Q series amplifier program user interface as following:

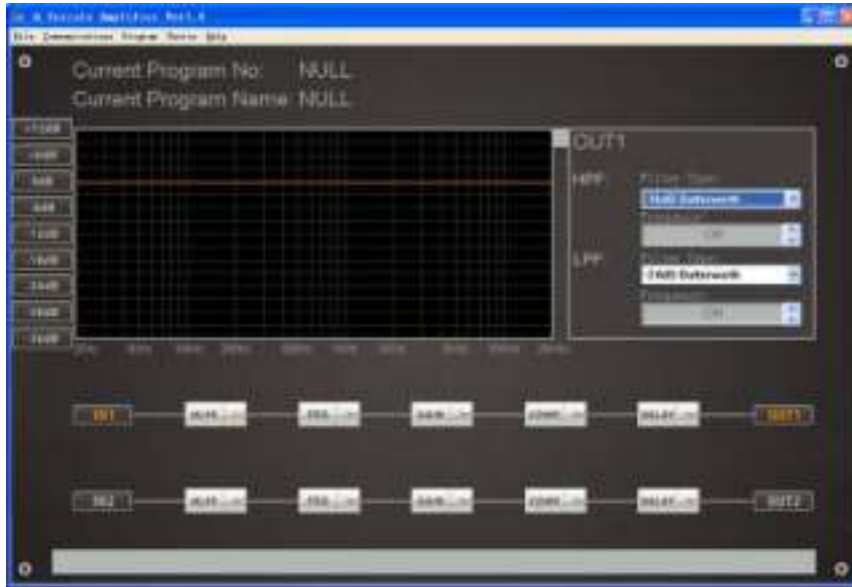

The interface includes all speaker function modules, total 5 menus for this software:

- 1.1> **File**: Open present config files or save present config into files.
- 1.2> **Communications**: Connect or disconnect equipment
- 1.3> **Program**: Obtain current using config information, like program number, program name and so on. Also edit or modify the information.
- 1.4> **Device**: Modify equipment information
- 1.5> **Help**: Display present software version

2> System connection

- 2.1> USB connection available, USB cable needed to connect this device.
- 2.2> Click Communication menu, choose “ Enable communications ” to connect this device, see below:

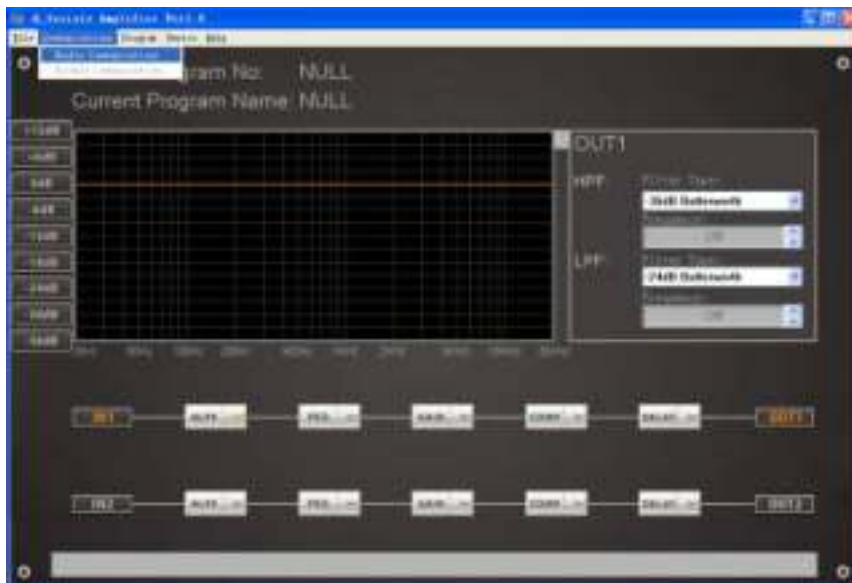

The software starts to search device automatically, meanwhile, the bottom column will show “ Search device ” , see below:

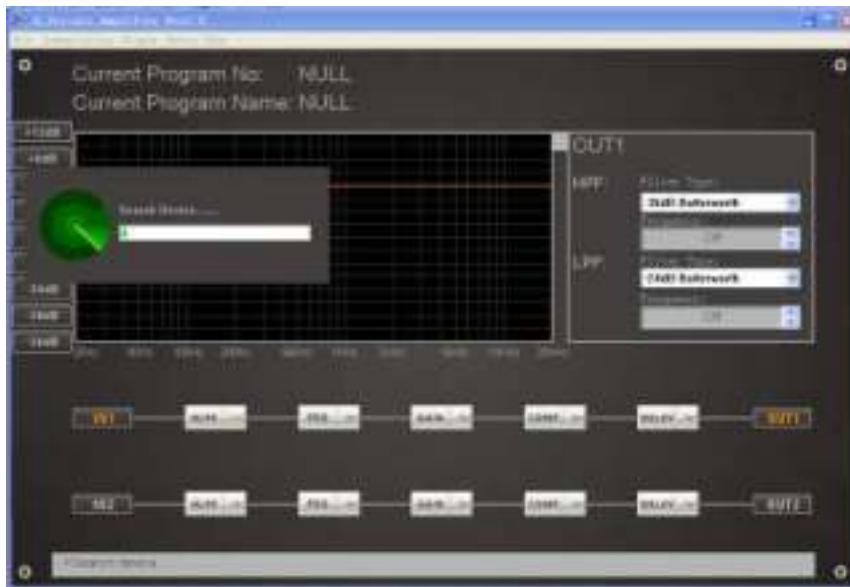

After finishing search, it will pop out as below if device is found:

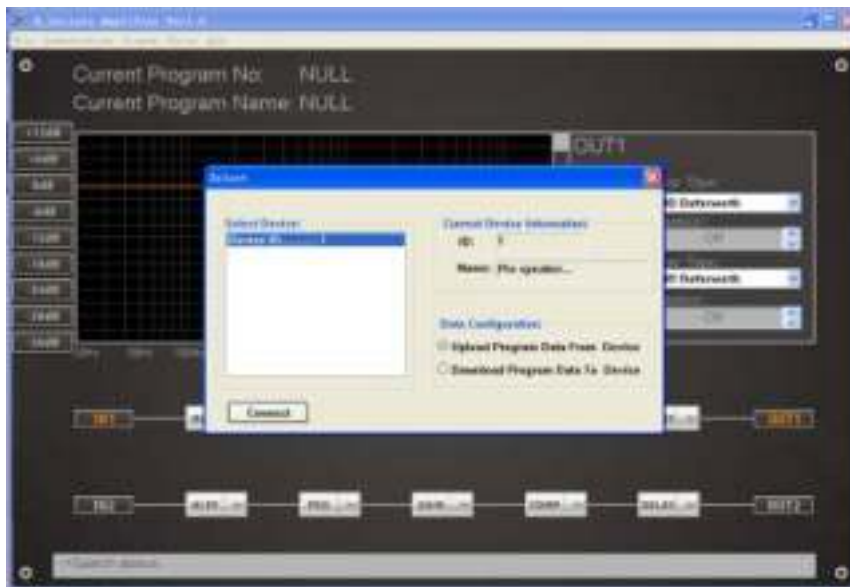

The left side of dialog box shows search result.

The right side of dialog box shows current device information and config data. If users want to open the config file, click “ Download Program Data to Device ” option (The option is just to write config data into RAM, if it's not saved for next, when device powered off, the config will lost.). Users want to connect the device, click “ connection ” and start connection.

After connecting successfully, the software will update the display automatically, and show the Information of currently connected device, and current program used by device, at the bottom column show “ -> **Program Data Transfer Ok...** ”, see below:

(Remark: When device is connected with PC, the device knob is no function and only control through PC).

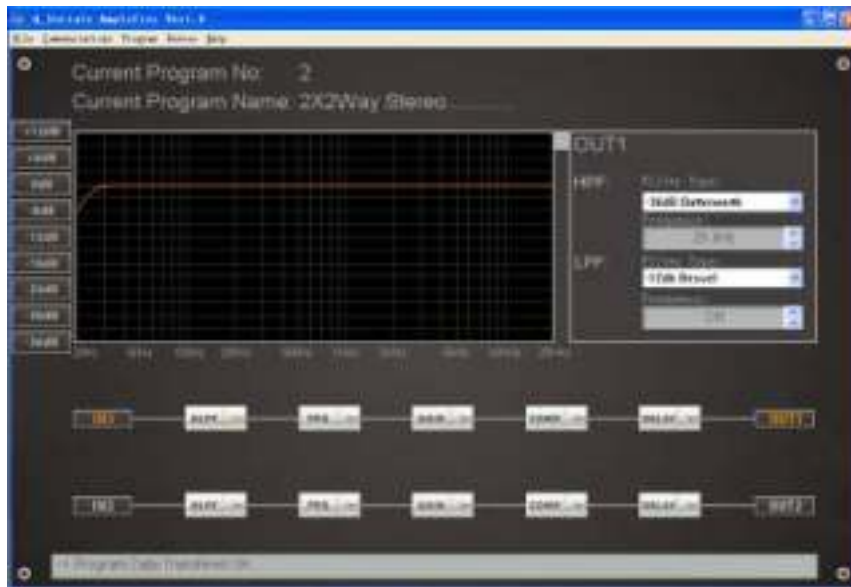

3> Save config files

3.1> Save as a file, When user finish the adjustment, the parameters can be saved as a file into PC through Save As in the file “ **menu** ”, see below

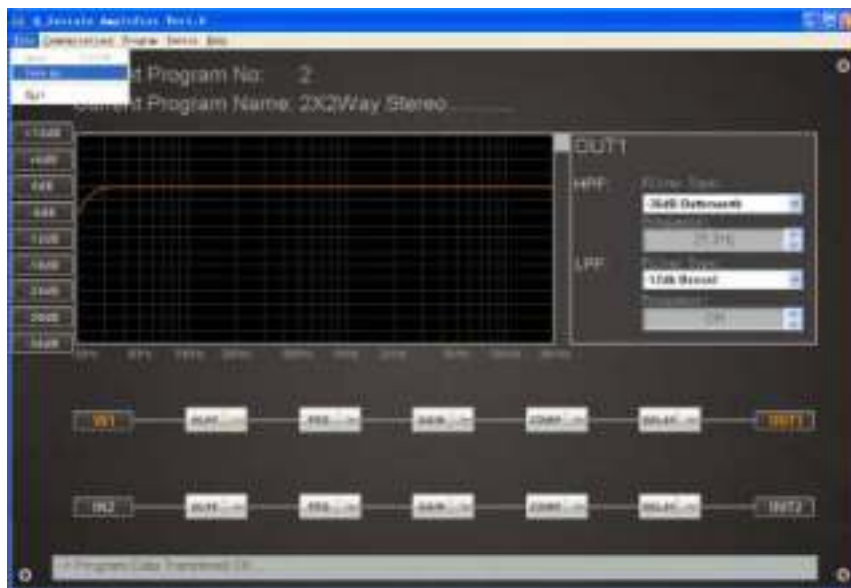

3.2> User also can save the adjusted parameters into the device directly
 Due storage space limit, total 50 programs can be saved through "**Save as current program In Device**" under "**Program**" menu. See below:

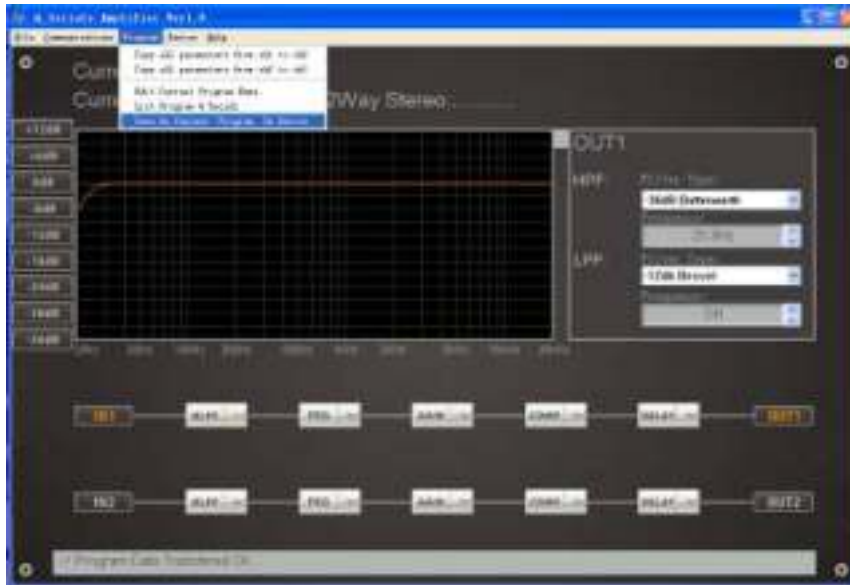

4> Recall config files

According to the different file source, there are two ways are available for recall the existing configuration files.

4.1> Regarding the files saved in the computer, it can be recalled from "**Open**" under "**File**" menu. Then connect the equipment, choose "**Download Program Data to Device**" in pop-out dialog box, see below



4.2> For the config files saved in the device, it can be recalled through “ **List Program & Recall** ” in “ **Program** ” menu, the software will read the data again and then update the display Automatically, see below:

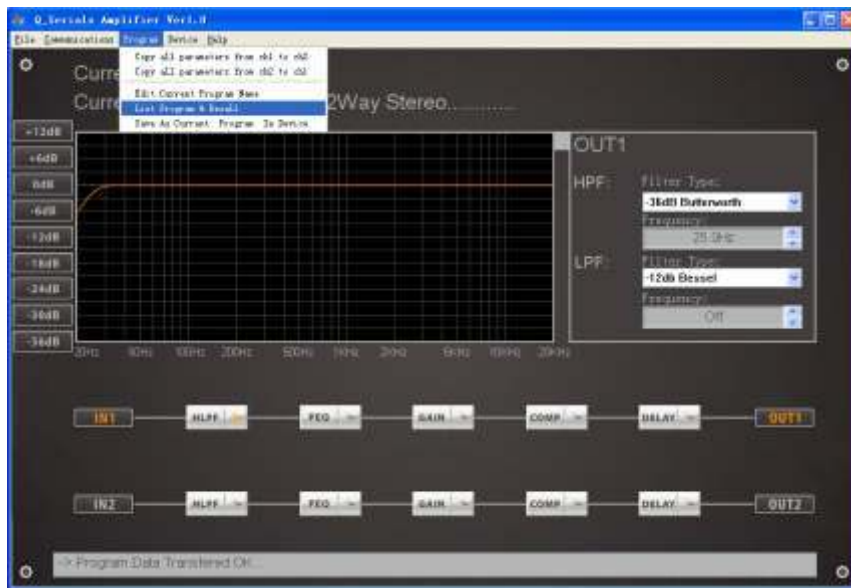

Select the program you want to use in the pop-out dialog box, then click “ **Recall** ” button, the Software.



4.3> Change the name of config files

Click “ **Edit current program Name** ” under “ **Program** ” menu to change the name of current Config files, see below:



5>. Disconnection

After finishing the adjustment of parameters, the current parameters can be saved into the device for the next power on default data. If user does not save the program into device, all the changes based on previous parameters will not be saved. Click "**Disable communications**" under "**communication**" menu for disconnection, please see below:

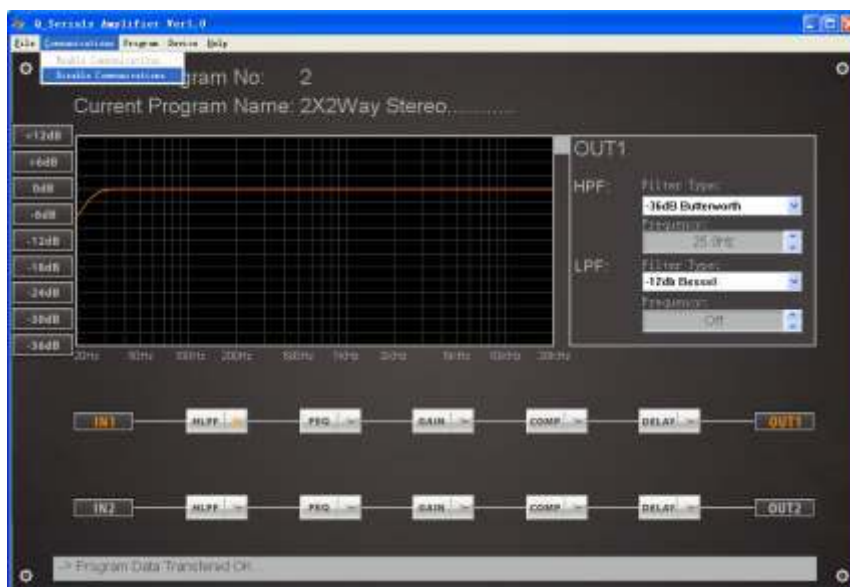

6> When device is connected OK by user, the parameters can be adjusted.

6.1> HPF and LPF adjustment, use mouse to choose HLPF key, the right side of screen can select the type and frequency of filter.

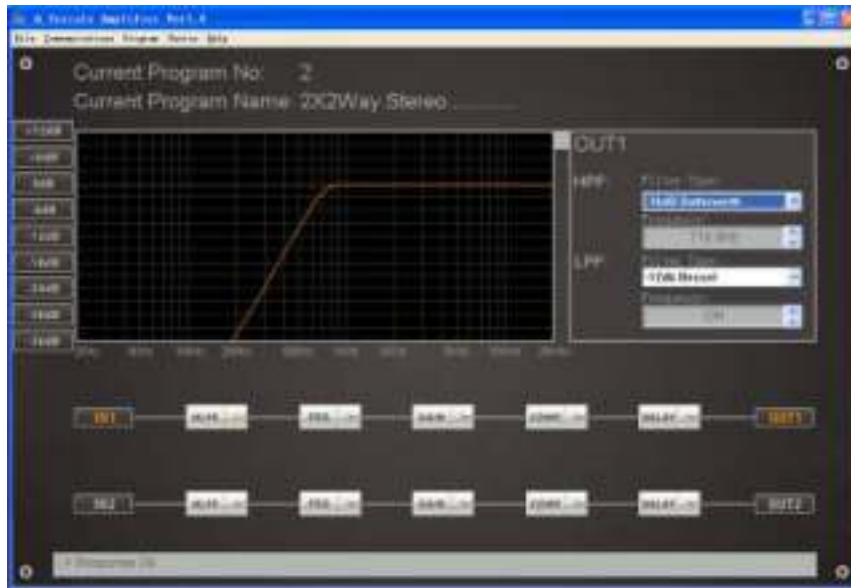

6.2> EQ filter adjustment: Choose below PEQ key, the right side of screen can select the type, frequency, Q value and level of filter. There are 8 EQ points for every channel, each EQ can set different filter type.

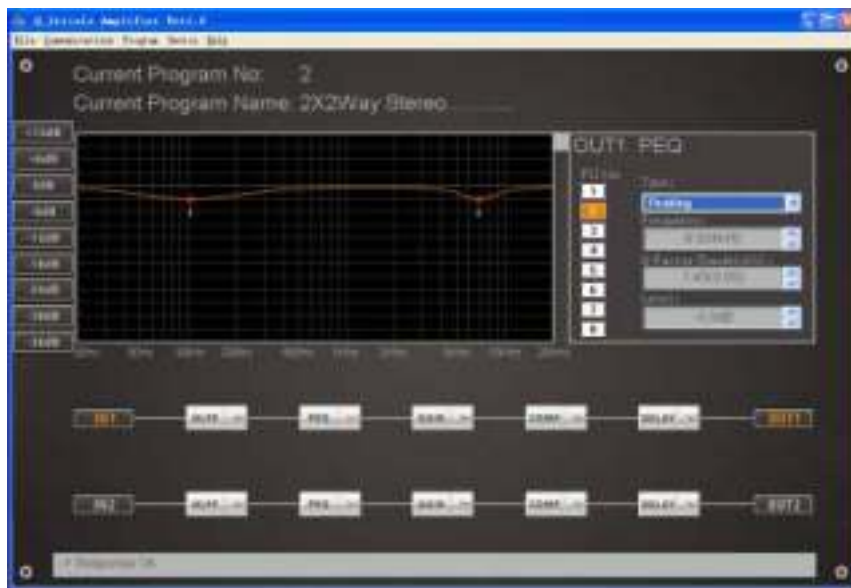

6.3> The channel gain and volume adjustment, use mouse to click below “ Gain ” key, the right side of screen can select channel phase and adjust the volume output.

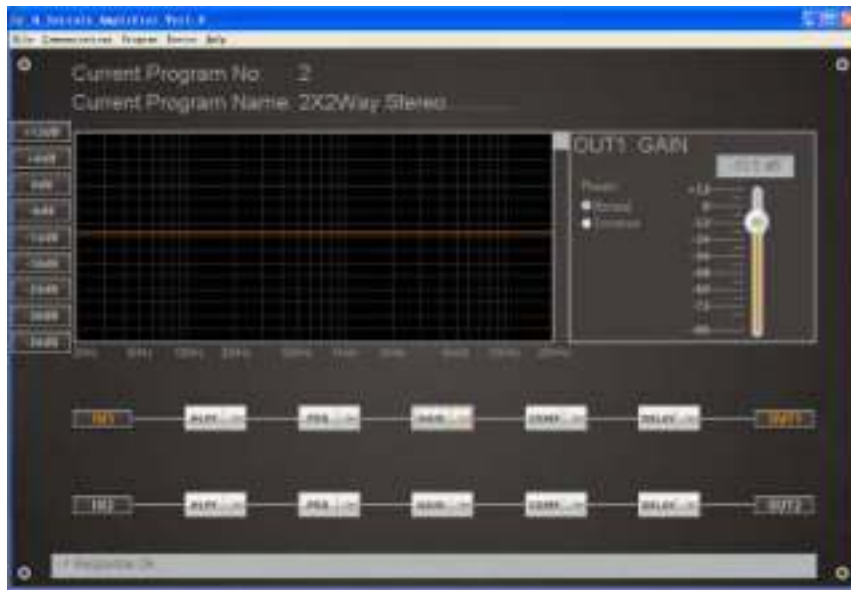

6.4> Channel power output compressor adjustment, use mouse to click below “ COMP ” key, the right side of screen can select compressor threshold, ratio, release time and attack time.

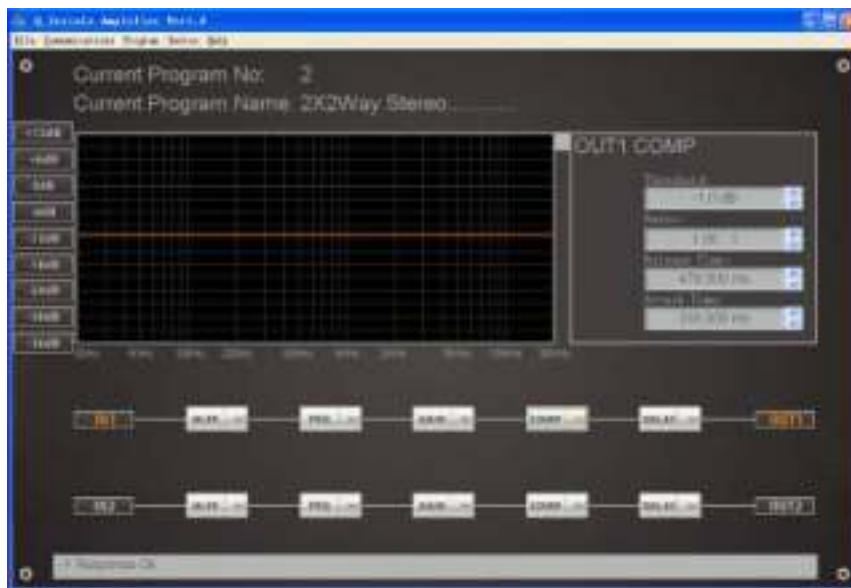

6.5> Channel delay time adjustment, use mouse to click below “ DELAY ” key, the right side of screen can adjust the delay time.

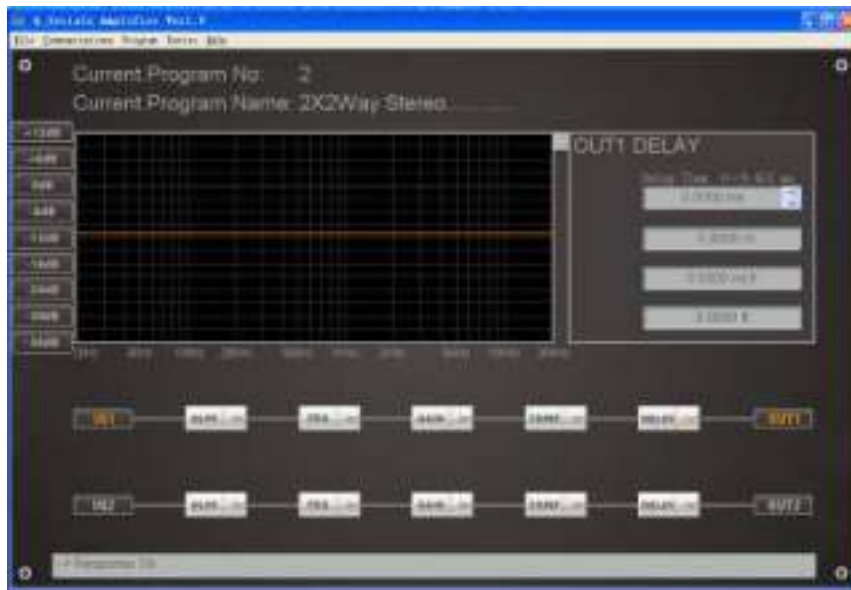

6.6> The data copy between channel 1 and channel 2, if channel 1 parameters are set up and channel 2 needs to same as channel 1, click “ **Copy all parameters from ch1 to ch2** ” under “ **Program** ” menu to realize.

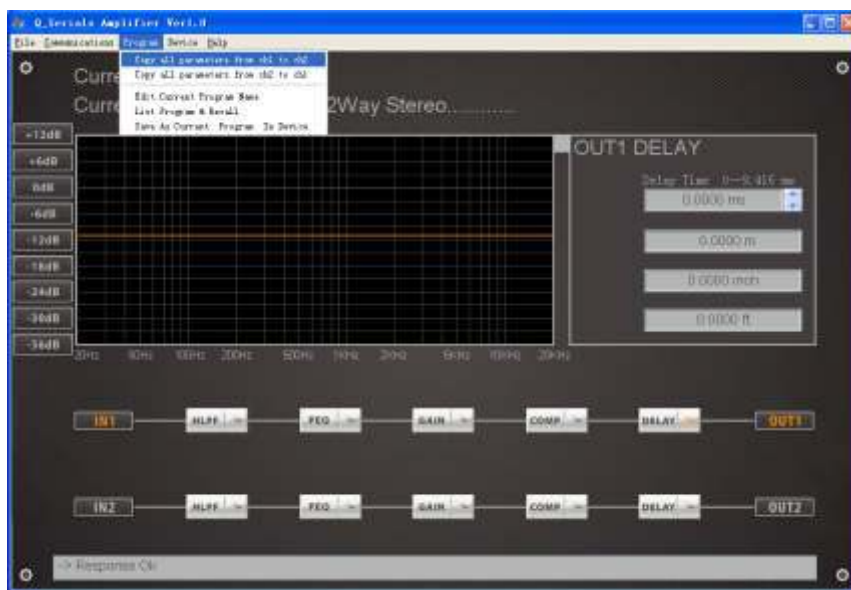

7> Auto backup mode

Set the mode switch of amplifier panel on **Stereo mode**, select “ Enable Auto backup ” , the amplifier operation is on auto backup mode. Now the left channel signal as main signal, all amplifier output signal are from left channel, when there is no signal from left channel and there is signal from right channel, the amplifier will be switched to right channel in very short time until there is signal from left channel, this design is to enhance the amplifier reliability. This mode also can be realized on amplifier panel, press the volume knob for 5 seconds, enter the parameter selection menu, choose “ ON ” to start auto backup function and “ OFF ” to close. The adjusted parameter will be saved on amplifier automatically.

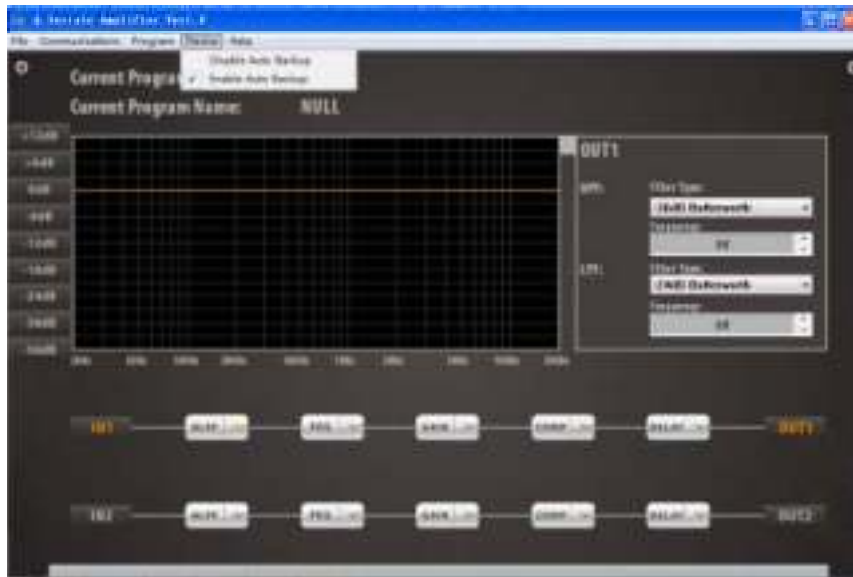

13.USB drive installation guide

File: CDM V2.12.00 WHQL Certified.exe, new version of FTDI USB TO RS-232 drive,
Use also go to FTDI website (www.ftdichip.com) to download the latest drive.
The new version drive installation is different from old one, just click the file for the installation.
Remark: If there is old version USB drive installed in computer before, the old version drive
needs to be removed firstly and then click “ **CDM V2.12.00 WHQL Certified.exe** ” to install.



14. PROTECTION AND COOLING SYSTEM FUNCTION

High efficient and safe working mode will lower the defected rate. Improper operation and bad application should be avoided.

- 1>Short circuit protection: when the load at the output end is short circuit, the equipment can cut off the signal and protect the equipment;
- 2>Output DC protection: when the equipment has faults and there is DC in output signal, the equipment can cut off output automatically and avoid damage for speaker caused by DC;
- 3>Overheat protection: If the temperature of heat sink exceeds the allowed temperature, the sensor will cut off the output , avoid damage caused by high temperature so as to protect the amplifier.

Bseriesamplifierhasgoodcoolingsystemdesignwith4pcsof80mmvariablespeedfantoensure airintake/outtakefromfronttorearisverysmoothandcoolingwellinsmallnarrowrackremainsstable. Thetemperaturecontrolsystemcanreducetheamplifierworkingtemperaturetoensureworkingstability. Temperaturecontrolcircuittesteachofhightemperatureparts.Keepadjustingcoolingfanspeedin theprocessof temperaturerisinginordertoreducethesystemtemperature.Itistheefficientwayto reducetheamplifierworkingnoiseandprolongtheworkinglifeoffan.

15. TROUBLES AND TROUBLE SHOOTINGS

Trouble	SN	Trouble shootings
No sound, no power indication	1	Check if the power plug and jack are connected well.
	2	Check If the power input is AC 220-240V,50Hz/60Hz.
	3	Check if the circuit breaker on rear panel is shut off, push it back.
No sound, power indicator is on, signal indicator is off	1	Check if the music signal cable is connected well.
	2	Check if the power of music source is turned on and the volume is turned on.
	3	Check If the amplifier volume is turned on.
CLIP indicator flashes, sound is abnormal	1	Check if the music source is too much output.
POWER indicator flashes, sound is abnormal	2	Check if there is any short circuit in output connections and if the load is correct. Then restart.
No sound on one channel under paralleled mono mode	1	Check if the switch of MODE on rear panel is at the PARALLEL, please put it at PARALLEL if it not at the position.
	2	Check if there is a volume pots channel is not turned on.
Low bridge output	1	Check the input signal level.
	2	Make sure it is at BRIDGE mode.
Power indicator stays at red	1	Check if the local voltage is same as the voltage of the equipment.
Others	1	Check if the setup and connection are in accordance with the user manual.

16. Safety attentions

SAFETY REGULATIONS

ABNORMAL PHENOMENA:

†Please turn off the power and pull out the plug when
You find unusual sound or smell when operation.

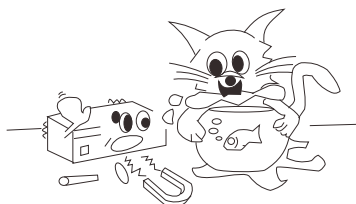
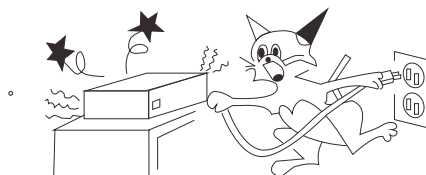

POWER CORDS PROTECTION

Don't touch power cords with wet hands to avoid
electric shock.
Don't put the cords in crowded people.

KEEP AWAY FROM WATER AND SUNDRY GOODS

DON'T OPEN THE COVER IF NOT GUIDED
BY A QUALIFIED ELECTRICIAN



PULL OUT THE POWER CORDS TO AVOID
FIRE WHEN YOU DON'T USE THIS UNIT

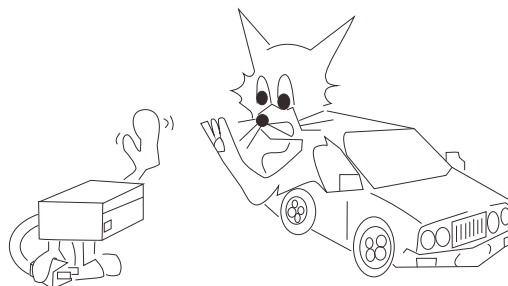



Q SERIES

PROFESSIONAL POWER AMPLIFIER