



User Manual

ED-B3-MA-050530-001

Beta three

PUBLIC ADDRESS AMPLIFIER

BA3240

DEAR CUSTOMERS:

Please read the user manual carefully before using BA-3240, and operate according to the user manual strictly. Any questions, please ask for the local distributor.

CONTENTS

1、	Attentions	P3
2、	Functions&features	P3
3、	Parameters	P4
4、	Front panel	P5
5、	Back panel	P5
6、	Power supply	P6
7、	Function setup and cable connection	P7
8、	Operations	P9
9、	Protection functions	P9
10、	Troubles and trouble shootings	P10

1、 ATTENTIONS

- ▲ Do not open the cover because exist dangerous voltage,please ask theprofessional to repair
- ▲ Do not expose it to the raining or moisture
- ▲ Do not put it under the direct sunshine,high temperature or heat source
- ▲ Keep good ventilation,not stop the ventilating hole
- ▲ Note the local voltage must matched with the voltage required
- ▲ Please put off the plug if not use for a long time
- ▲ Connect with right load, not work under overload for a long time
- ▲ Do not let the obstacle into the unit, keep the unit away the obstacles
- ▲ Please stop using if the cable is damaged

■ Symbols:

- The equilateral triangle with lightning bolt warns the user of dangerous voltage levels localized within the cabinet.
- The equilateral triangle with exclamatory mark means the important operation on the user's manual.

2、 FUNCTIONS&FEATURES

BA-3240 is a integrated amplifier with completed functions,can meet the demand of small public address system separately.

- 1.> Five channels input
INPUT1-INPUT4 can be choosed to be balanced microphone input with low impedance, built-in 24V eidolon power microphone input or line balance input with high impedance. INPUT5 is unbalanced line input with high impedance,INPUT1 is fault channel,can control other channel output
- 2.> Balanced rated voltage output with 120V、 100V、 75V、 50V、 25V, 4 Ohms rated impedance output and 8 /1W monitor output are optional
- 3.> Can external connect equipments
- 4.> Separately volume control for each channels,the total volume control is also available and convenient
- 5.> HF/LF adjust
- 6.> Seven sections LED indicators
- 7.> Separated areas with Six channels
- 8.> The DC 24V interface is available under the urgent situation to provide the power supply when the local voltage has problems
- 9.> Power supply is optional for 110V/220V
- 10.> Auto power off function under Output short circuit,over loading, overheat protection

3、PARAMETERS

MODEL	BA3240
(THD<1%) RMS	240W
Frequency response (+0/-3dB)	50Hz-16KHz
Output terminal	8 /1W monitor, 4-16 rated impedance 25V, 50V, 75V, 100V, 125Vrated voltage
INPUT SENSITIVITY/IMPEDANCE	
INPUT1-INPUT4 microphone input	10mV/1K (Balanced)
INPUT1-INPUT4 line input	200mV/30K (Balanced)
INPUT5 input	200mV/50K (Unbalanced)
THD	<0.5% @1KHz 24W
S/N RATIO: (A-WEIGHT)	
Microphone	>70dB
Line	>80dB
REC OUT/impedance	1V/1K
TONE CONTROL	
LF	> ± 6dB @100Hz
HF	> ± 6dB @10KHz
Mute	>36 dB
Power supple	AC 220V-240V~, 50/60Hz (or AC 110V-120V~, 50/60Hz)
Dimensions(W*H*D)	316 × 88 × 250mm
Net weight	15.6Kg
Gross weight	16.4Kg

4、 FRONT PANEL

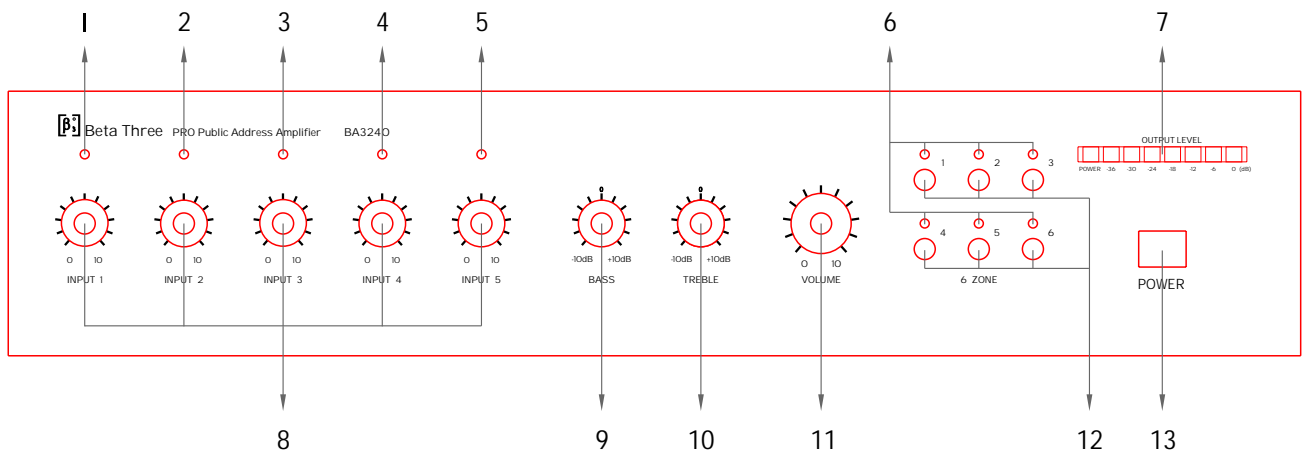

- | | |
|----------------------------------|-----------------------------------|
| 1. Signal indicator for input 1 | 8. Volume control for channel 1-5 |
| 2. Signal indicator for input 2 | 9. LF Adjust |
| 3. Signal indicator for input 3 | 10. HF Adjust |
| 4. Signal indicator for input 4 | 11. Total volume control |
| 5. Signal indicator for input 5 | 12. Channel switch for area 1-6 |
| 6. ON/OFF indicator for area 1~6 | 13. Power |
| 7. Output level indication | |

5、 BACK PANEL

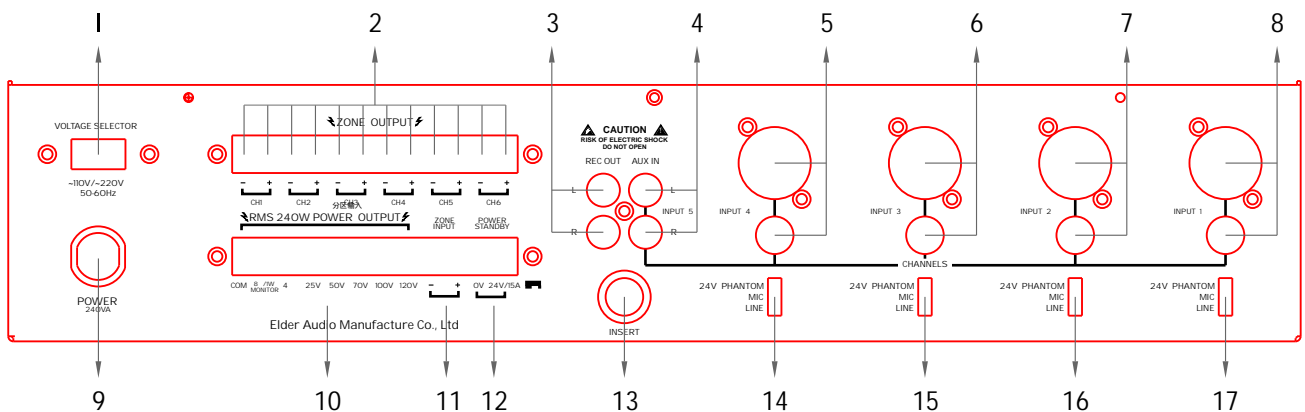

- | | |
|--------------------------------------|---------------------------------|
| 1. 110 / 220V Power Switch | 10. Power amplifier output clip |
| 2. Distribution zone output terminal | 11. Distribution terminal clip |
| 3. Recording output terminal | 12. 24V/10A DC voltage |
| 4. Channel 5 input | 13. Insert terminal |
| 5. Channel 4 input | 14. Channel input 4 terminal |
| 6. Channel 3 input | 15. Channel input 3 terminal |
| 7. Channel 2 input | 16. Channel input 2 terminal |
| 8. Channel 1 input | 17. Channel input 1 terminal |
| 9. Power supply | |

6、 POWER SUPPLY



Please ensure that the back voltage showing is according with the local voltage

This unit have voltage selector, can be used for different voltage

Before operation, please chck the local voltage is optional for the 110/220V selector voltage, you can connect it if correct and optional. If not optional, please put the selector to the correct voltage value, please note cut off the power supply when select.

The operation as:

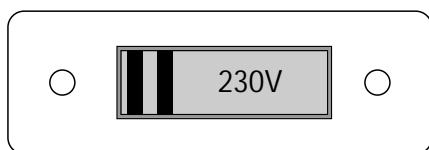

THIS IS OPTIONAL FOR 220V

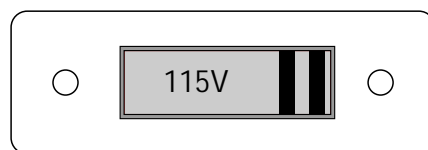

THIS IS OPTIONAL FOR 110V

Be sure that the power input socket is good, power cable is not damaged when connecting, Please power off when not using unit.

The normal working voltage is 250VA, the peak power cost about 600VA.

Note:

When selected to 220V, please use 5A 5*20mm delay style fuse

When selected to 110V, please use 10A 5*20mm delay style fuse

Please use the correct fuse when voltage power changed

Note that the voltage will be put to 220 when leaving factory

7、 FUNCTION SETUP AND CABLE CONNECTION

1> Unit connecting

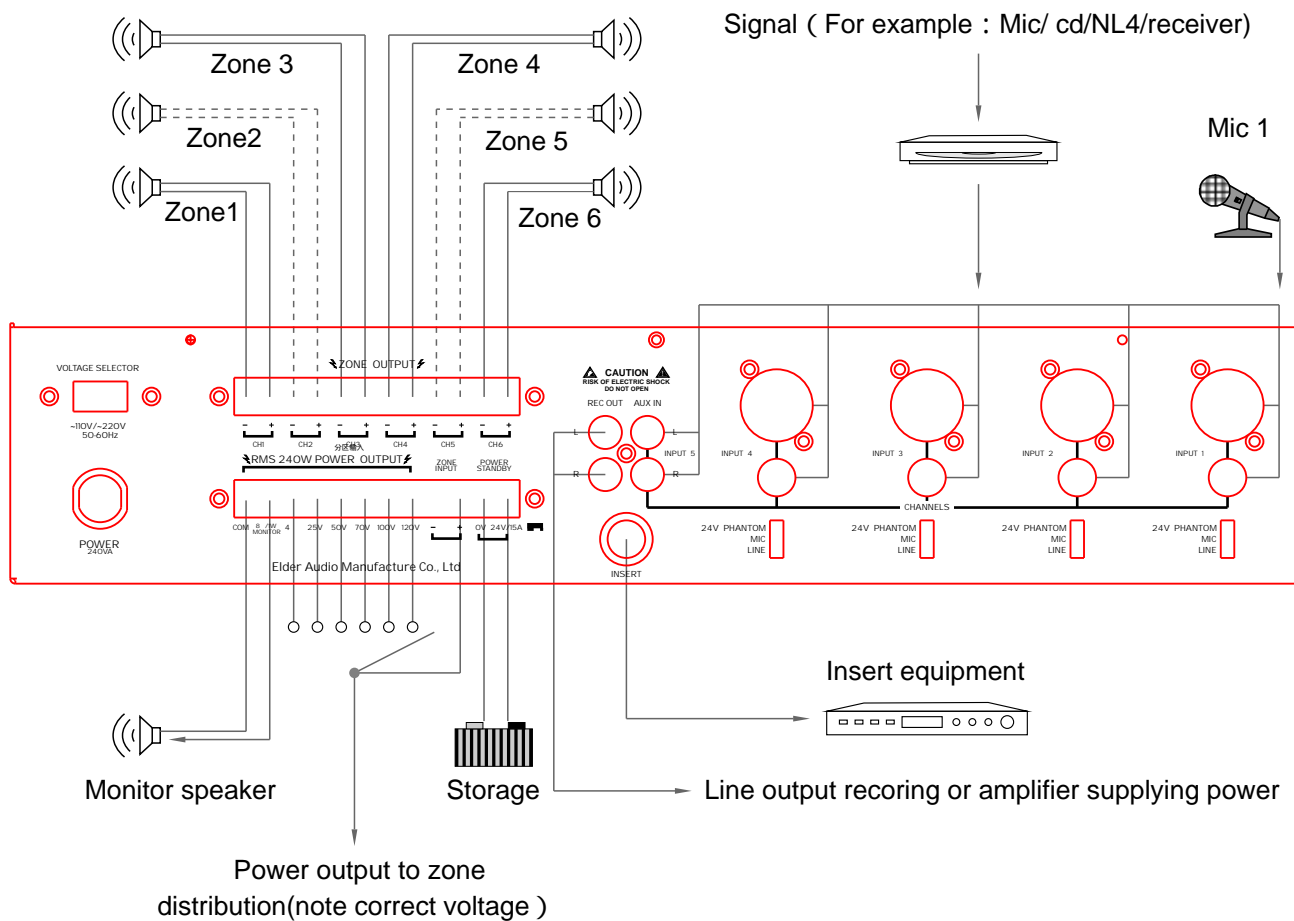

2> input plug connecting

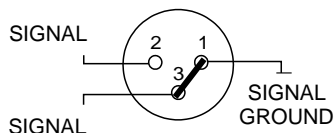

INPUT1-INPUT4 is unbalanced input, as left connecting

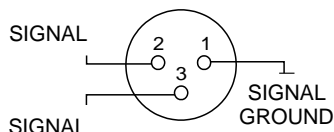

INPUT1-INPUT4 is balanced connecting, as left connecting

Note:

Channel input1 is priority channel, should be inserted urgency microphone or fire fighting signal.

7、 FUNCTION SETUP AND CABLE CONNECTION

3> input sensitivity:

You should know the signal character before connecting, then connect to this unit correct channel.

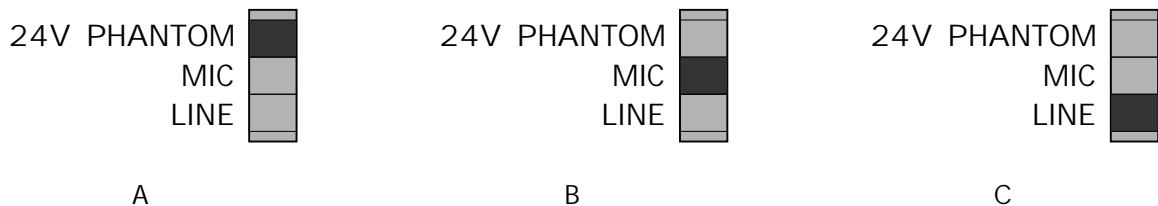

A indicates that the channel is set to 24V phantasm microphone input, the input sensitivity is 10mV

B indicates that the channel is set to microphone input, the input sensitivity is 10mV

C indicates that the channel is set to line input, the input sensitivity is 200mV

4> Insert equipment connecting

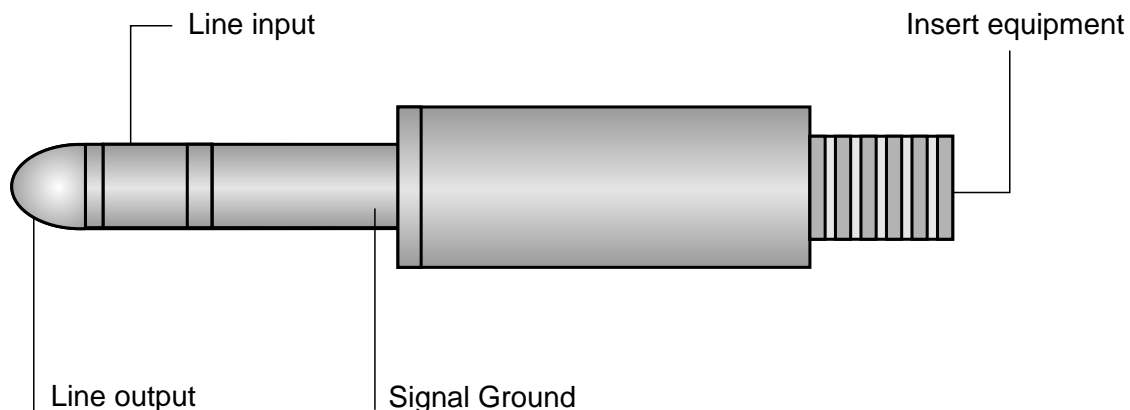

Connected equipment can be selected based on your need, please connect as above drawing

5> Zone distribution connecting

Connect correct output voltage to the zone terminal based on your needs

6> Output connecting

Please select correct voltage of broadcast to connect with relative interface of the BA3240
Can connect many loudspeaker in parallel connection. But the total power can not be over 240W

8、 OPERATIONS

PLEASE OBEY THE FOLLOWING:

1、 Start

- a、 set the right function and connect the right cable
- b、 check the output line and see if it is short circuit or loading is too low
- c、 check the local voltage is same as the require of power
- d、 adjust the volume to Min
- e、 connect the power supply,then open the sound source,pre and effect equipments,
† must sure all equipments work well
- f、 Open the power supply,and sure the indicator is lit up
- g、 Adjust the volume to right place clockwise

2、 Put off

- a、 adjust volume to Min. counter-clockwise
- b、 put off the power supply,and sure the indicator off
- c、 put off the pre and effect equipments and sound source equipment

3、 Volume adjust

Connect the input signal and open the sound source,adjust the volume,if the indicator is not lit up,please check the sound source.Adjust according to the voltage output and the signal.When 0dB output voltage is lit up,the output is RMS, if is too much,will cause the distortion

4、 Area setting

Six buttons and six yellow indicators, when the six indicators are lit up, it means that there are output in six areas,press the area button, the relative area will be closed and the indicators will be off

9、 PROTECTION FUNCTIONS

BA-3240 Completed functions give the amplifier and speaker a good protection to avoid the damage, like short circuit,overloading,and overheat.

- 1、 **Circuit protect:** when exist the short circuit,it will be off automatically
- 2、 **Cverload protect :** it will be off automatically when input impedance is too low
- 3、 **Overheat protection:** if the temperature heatsink is over the standard degree.
If the unit will be back to required range,the nuit will be back to home

10、 TROUBLES AND TROUBLE SHOOTINGS

Status	#	Solutions
No sound,and the indicator is not lit up	1	Check power plug connection
	2	Check the voltage 220V/110V
	3	Check the fuse
No sound, the power indicator is lit up, And signal indicat or is not lit up	1	Check the input signal
	2	If open the power supply and adjust the volume
	3	Check the volume electroform
Overload indicator is too right.the sound is not good	1	The output is too big or not
	2	Check the sensitivity setting
	3	Check the volume is too big or not
Signal indicator is normal,no output	1	Check the output connecting, Check The loading
Fuse damaged	1	Check the local voltage
	2	Check the fuse specification
Others	1	Check if the setup and connection are accordant with the user manual
	2	Ask for the distributor

If it does not work according to the above steps,please ask for the professional to repair.



User Manual

BA3240
PUBLIC ADDRESS AMPLIFIER