



Beta Three

T4.6

4 x 6 line array full
range column speaker

User Manual

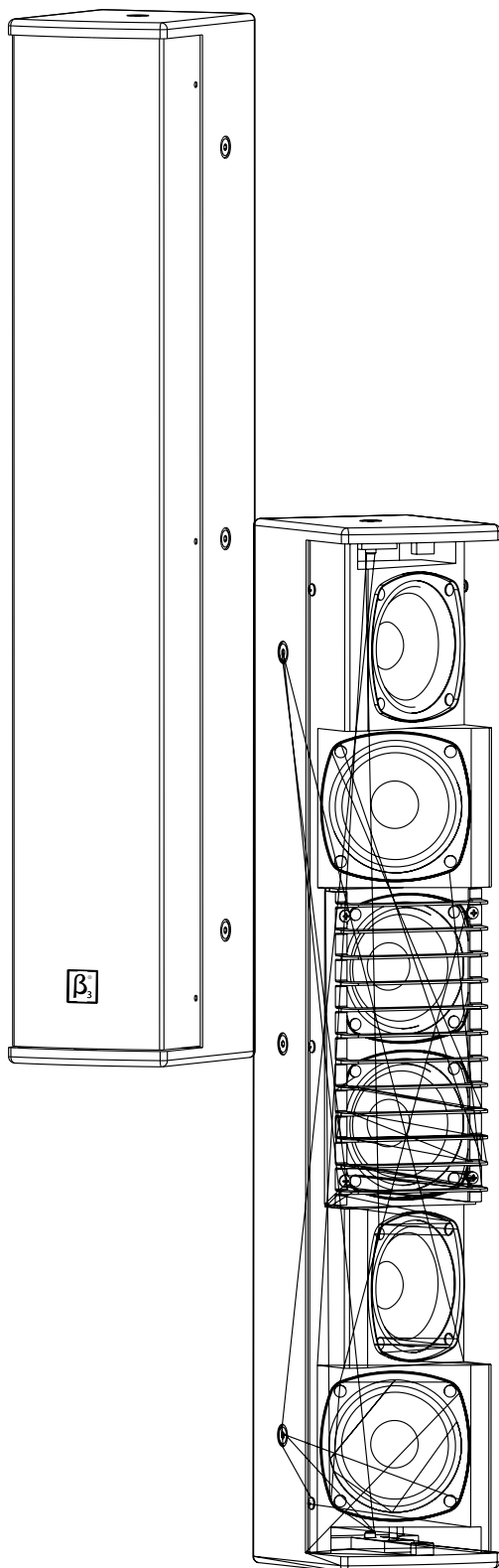



UM - T4. 6 - 20090507 ver A



SAFETY INSTRUCTIONS

PLEASE READ THIS MANUAL FIRST

Thank you for a buying β_3 product. Read this manual first as it will help you operate the system properly. Please keep this manual for future reference.

⚠ WARNING: *This product must be installed by professionals. When using hanging brackets or rigging other than those supplied with the product, please ensure they comply with the local safety codes.*

	CAUTION RISK OF ELECTRICAL SHOCK DO NOT OPEN	
CAUTION: TO REDUCE THE RISK OF ELECTRIC SHOCK, DO NOT REMOVE COVER (OR BACK). NO USER-SERVICABLE PARTS INSIDE. REFER SERVICING TO QUALIFIED PERSONNEL.		

	AVIS RISQUE DE CHOC ÉLECTRIQUE NE PAS OUVRIR	
ATTENTION : POUR RÉDUIRE LE RISQUE DE DÉCHARGE ÉLECTRIQUE, NE RETIREZ PAS LE COUVERCLE (OU L'ARRIÈRE). IL NE SE TROUVE À L'INTÉRIEUR AUCUNE PIÈCE POUVANT ÊTRE RÉPARÉE PAR L'USAGER. S'ADRESSER À UN RÉPARATEUR COMPÉTENT.		

 **The exclamation point within an equilateral triangle is intended to alert you to the presence of important operating and servicing instructions.**

⚠ ATTENTION: *Don't refit the system or spare parts without being authorized as this will void the warranty.*

⚠ WARNING: *Don't place naked flames (such as candles) close to the equipment.*

1. Read the instruction manual first before using this product.
2. Please keep this manual for future reference
3. Pay attention to all warnings.
4. Obey all operating instructions.
5. Do not expose this product to rain or moisture.
6. Clean this equipment with a dry cloth.
7. Do not block any ventilation openings. Install according to manufacturer's instructions .
8. Do not install this product near any heat source, such as a, heater, burner, or any other equipment with heat radiation .
9. Only use spare parts supplied by the manufacturer.
10. Pay attention to the safety symbol on the outside of the cover.



CONTENT

PRODUCT INTRODUCTION	3
Main Features	3
Product Description	3
Applications	3
CONNECTION	4
Push Terminals	4
System Reference Diagram	4
INSTALLATION	5
Optional Installation Accessories	5
Installation Options	5
TECHNICAL SPECIFICATIONS	6
Specifications	6
Frequency Response and Impedance Curve	6
Dimensions	7

 Product information may be updated without notification, please visit www.elderaudio.com for latest update.

T4.6

4 x 6 line array full range column speaker

Main Features

- A vertical line array of 6 x 4" full range transducers providing high fidelity sound.
- Frequency response 90Hz-16KHz(-3dB).
- Sensitivity 92dB, Max SPL 115dB.
- Dispersion 180° x 25°.
- Rated power 180w, max power 720w.
- Plywood cabinet with durable textured paint finish.
- Can be installed alone or stacked in multiples using the optional accessories. Suitable for many venues including inside and outside undercover environments.
- Patents pending for central diffuser plate.
- Designed for high speech intelligibility and natural sounding music.
- Quick install U bracket included.

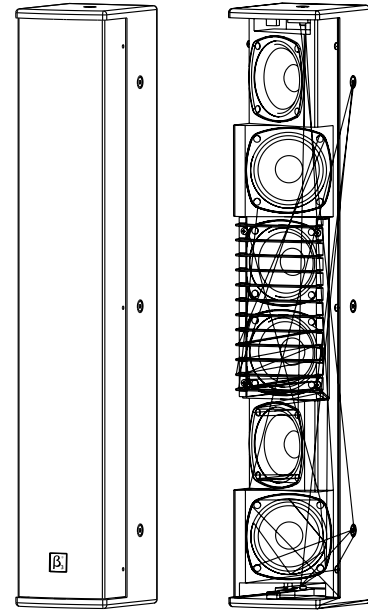

Product Description

The β³ T4.6 line array full range column speaker is one of three speakers in the T Series. This attractively designed, 180W RMS, innovative speaker delivers high speech intelligibility and natural sounding music in a wide range of applications through its 4" full range drivers. A vertical line array of 6 drivers provides control over a horizontal and vertical pattern of 180° x 25° and reproduces the critical vocal range 90Hz-16kHz without requiring a processor.

A diffuser plate (patent pending) is fitted to the centre drivers to assist with the vertical pattern control. The T4.6 speaker can either be used in singles, multiples or stacked using the optional accessories in many indoor applications such as Houses of Worship, Shopping Malls, Transport Terminals, Theme Parks, Meeting Rooms, Schools, Small Auditoriums. When stacking the T4.6 end on end to create a taller line array the height of the line array must correspond to the ear height range of the listeners in both seated or standing positions.

The T4.6 is manufactured from 15 mm plywood meeting a tensile strength of 3500N and is finished in either black or white using a very durable textured paint. The metal speaker grill is powder coated and passes all rust resistance tests.

The T4.6 is shipped with a quick install U bracket.

Adding the optional line transformer accessory makes the T4.6 line array speaker very versatile in 70/100v systems. To enhance the already great performance of the T4.6 you can use the EQ filters provided.

Applications

- churches/temples
- multifunction halls
- meeting rooms
- schools
- small auditoriums
- shopping malls
- transport terminals
- theme parks

The T4.6 rear panel has two input connectors. You can choose to use either the 4 way push terminal connector or the NL4 speakon connector. The two connectors are paralleled for through connection.

Push Terminals

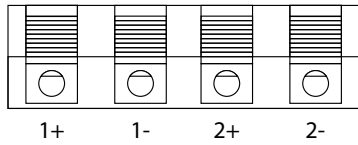

1+ 1- INPUT

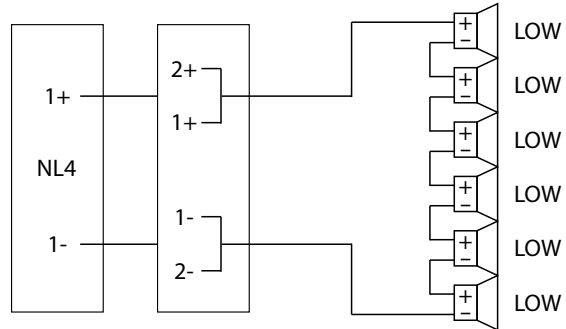

Speakon NL4

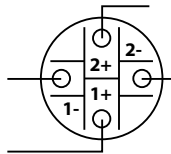

System Reference Diagram

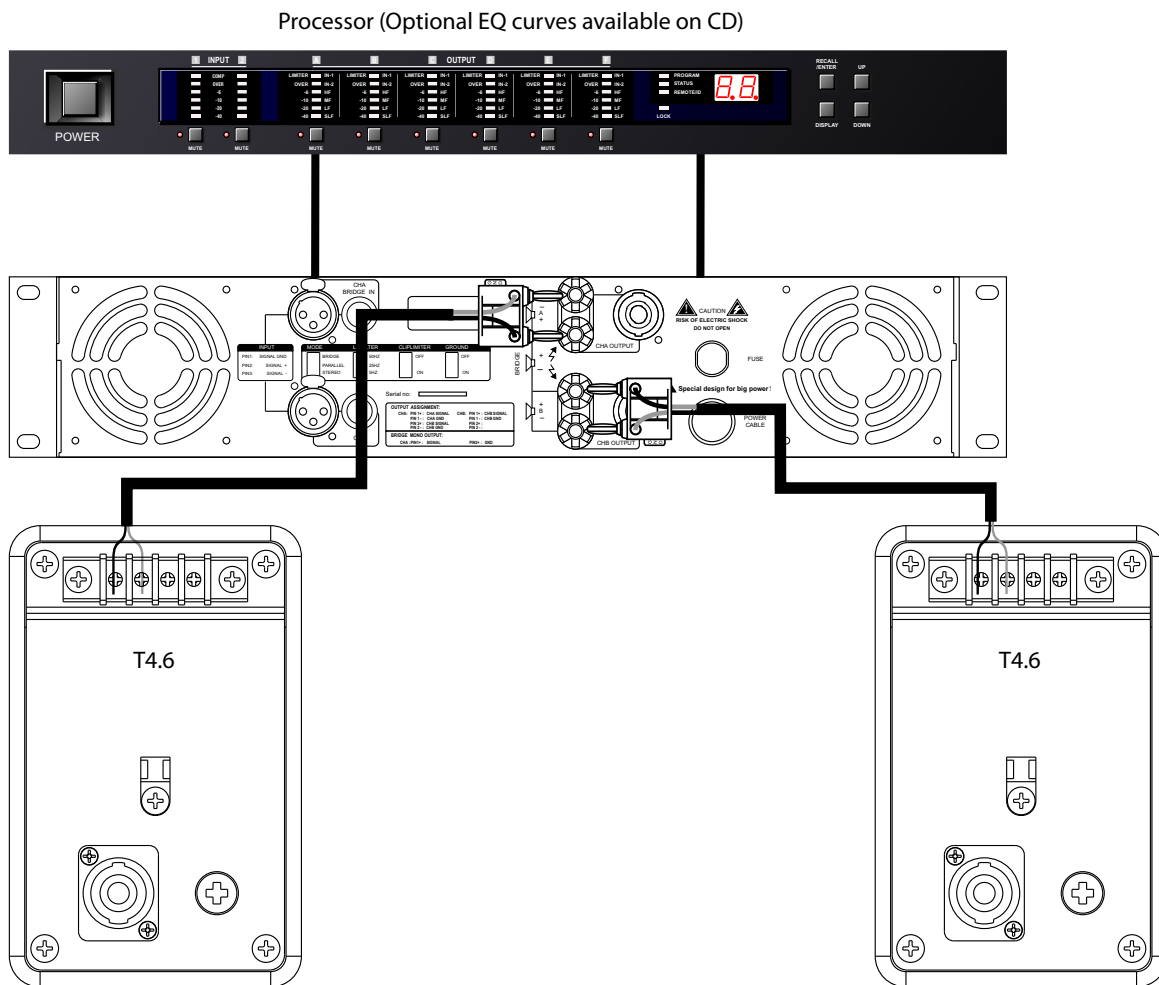

Warning: Please make sure the speaker impedance and polarity match the amplifiers.

Optional Installation Accessories

The T4.6 cabinet has 3 flying points, plus a stand mount adaptor to ensure fast and easy installation. To install stacked speakers there are an optional coupling brackets.

1. Wall bracket



2. Speaker coupling brackets

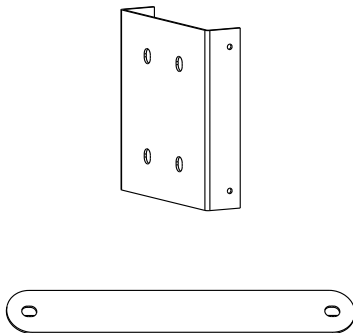

3. Stand mount adaptor

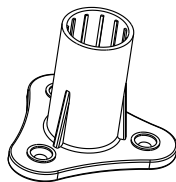

4. Tripod



Installation Options

1. Flying

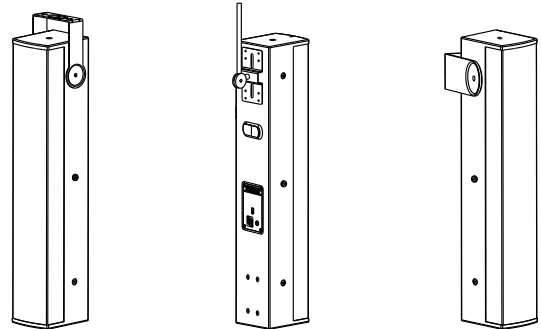

Ceiling mount

Extension mount

Wall mount

2. Stand mount

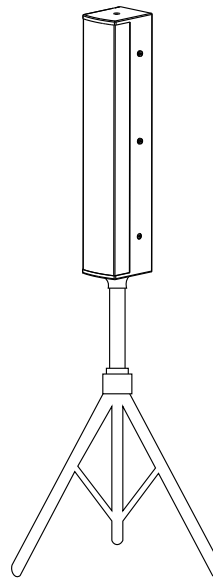

3. Speaker coupling

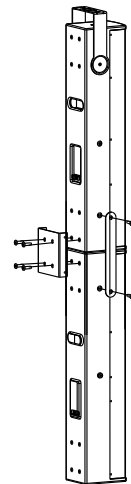

Warning: Always ensure the mounting accessories safety factor is not less than 5:1 or that it meets the local standards.

Specifications

Product:	Passive Wooden Speaker
Transducer:	6 x 4" Full range transducers
Frequency Response(-3dB):¹	90Hz-16kHz
Frequency Response(-10dB):	80Hz-17kHz
Sensitivity(1W@1m):²	92dB
Maximum. SPL(1m):³	115dB/121dB(PEAK)
Power:	180W (RMS) ⁴ 360W (MUSIC) 720W (PEAK)
Dispersion Angle (HxV) :	180° x 25°
Rated Impedance:	8 ohms
Cabinet:	15mm plywood construction
Installation:	Mounting U bracket included and optional mounting points provided.
Paint:	White durable textured finish
Grill:	White powder coated , 0.8mm steel mesh.
Connector:	Screw terminal and 1 NL4 Speakon
Dimension(WxDxH):	135x169x800mm (5.3x6.7x31.5in)
Packing Dimension(WxDxH):	240x205x900mm (9.4x8.1x35.4in)
Net Weight:	9kg (19.8 lbs)
Gross Weight:	10kg (22.0 lbs)
Optional Accessories:	Coupling bracket, Stand adaptor, Tripod

Speaker Testing Method

1. Frequency Response

Use Pink noise to test the speaker in the anechoic chamber, adjust the level to make the speaker work at its rated impedance and set the output power at 1W, then test the frequency response 1m away from the speaker.

2. Sensitivity

Use full range Pink noise which has been modified using an EQ curve to test the speaker in the anechoic chamber, increasing the signal to make the speaker work at its rated impedance and set the power output at 1W, then test the sensitivity 1m away from the speaker.

3. MAX.SPL

Use full range Pink noise which has been modified using an EQ curve to test the speaker in the anechoic chamber , increase the signal to make the speaker work at its maximum power output level, then test the SPL1m away from the speaker.

4. Rated Power

Use Pink noise to the IEC#268-5 standard to test the speaker, increase the signal for a continuous period of 100 hours, the rated power is the power when the speaker will show no visible or measurable damage.

Technical Specifications

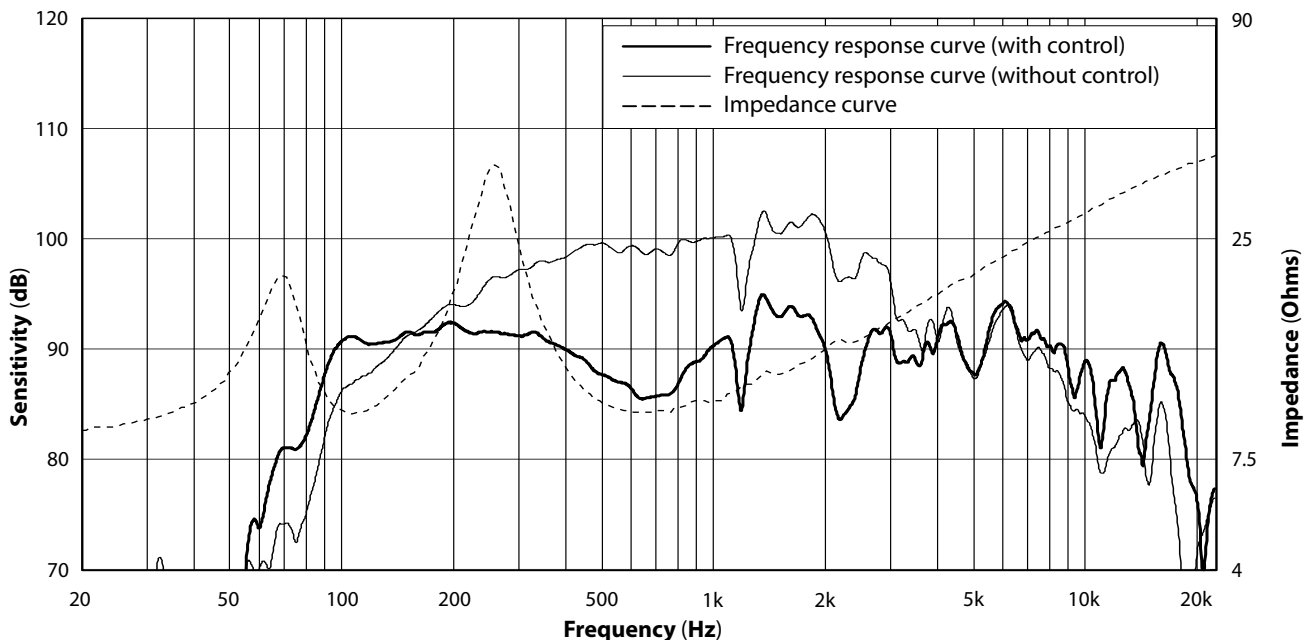

Dimensions

Top view

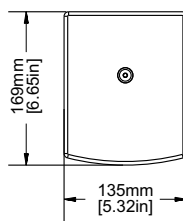

Side view

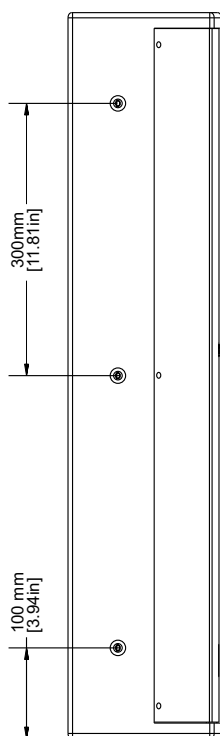

Front view

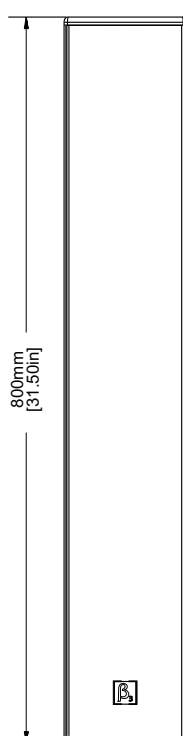

Back view

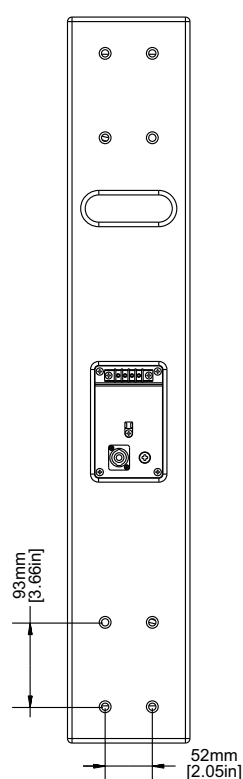

Bottom view

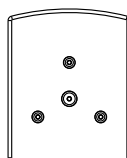

Notes:



Beta Three