



Beta Three

TW215

Dual 15" Two Way Full
Range Passive Speaker
TW Series Pro Loudspeaker System

User Manual

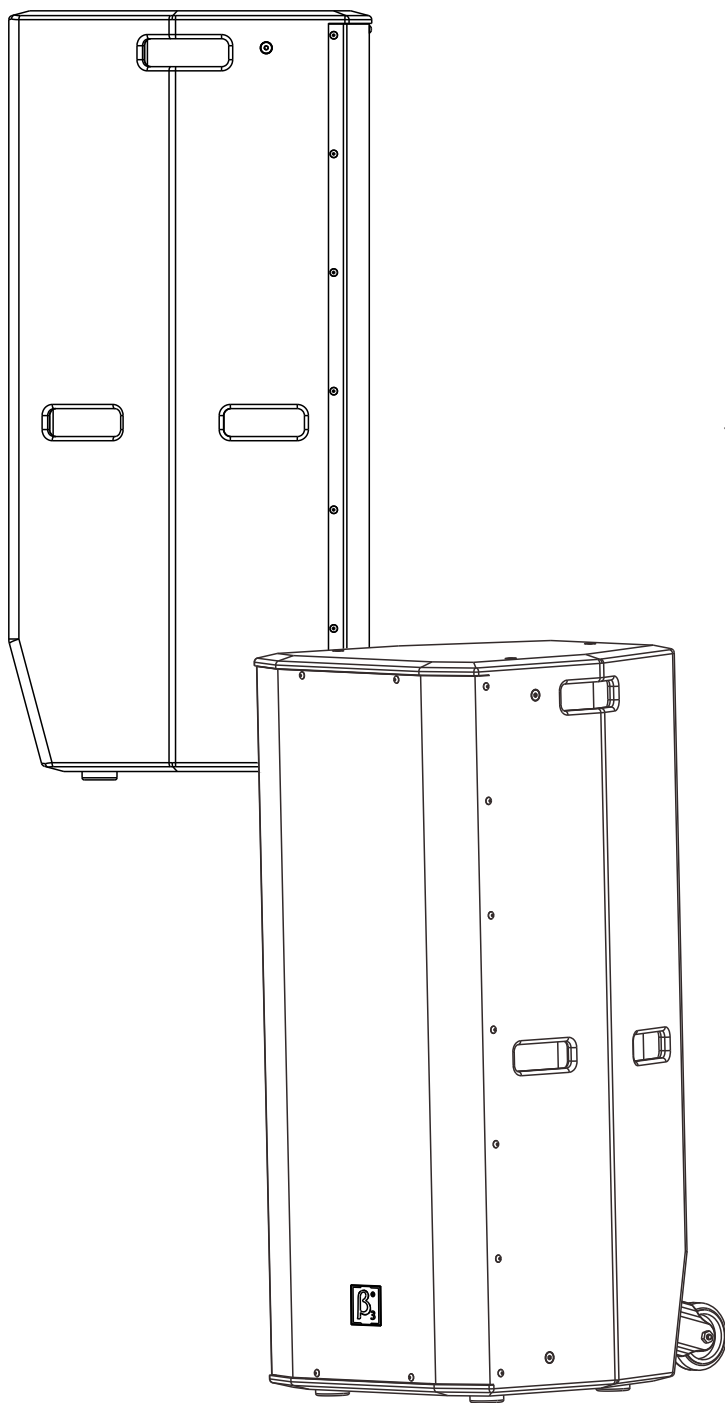



UM-TW215-20130929 ver A



SAFETY INSTRUCTIONS

PLEASE READ THIS MANUAL FIRST

Thank you for a buying β_3 product. Read this manual first as it will help you operate the system properly. Please keep this manual for future reference.

 **WARNING:** *This product must be installed by professionals. When using hanging brackets or rigging other than those supplied with the product, please ensure they comply with the local safety codes.*

| | | |
|---|---|---|
|  | CAUTION RISK OF ELECTRICAL SHOCK DO NOT OPEN |  |
| CAUTION: TO REDUCE THE RISK OF ELECTRIC SHOCK, DO NOT REMOVE COVER (OR BACK). NO USER-SERVICABLE PARTS INSIDE. REFER SERVICING TO QUALIFIED PERSONNEL. | | |

| | | |
|--|---|---|
|  | AVIS RISQUE DE CHOC ÉLECTRIQUE NE PAS OUVRIR |  |
| ATTENTION : POUR RÉDUIRE LE RISQUE DE DÉCHARGE ÉLECTRIQUE, NE RETIREZ PAS LE COUVERCLE (OU L'ARRIÈRE). IL NE SE TROUVE À L'INTÉRIEUR AUCUNE PIÈCE POUVANT ÊTRE RÉPARÉE PAR L'USAGER. S'ADRESSER À UN RÉPARATEUR COMPÉTENT. | | |

 *The exclamation point within an equilateral triangle is intended to alert you to the presence of important operating and servicing instructions.*

 **ATTENTION:** *Don't refit the system or spare parts without being authorized as this will void the warranty.*

 **WARNING:** *Don't place naked flames (such as candles) close to the equipment.*

1. Read the instruction manual first before using this product.
2. Please keep this manual for future reference
3. Pay attention to all warnings.
4. Obey all operating instructions.
5. Do not expose this product to rain or moisture.
6. Clean this equipment with a dry cloth.
7. Do not block any ventilation openings. Install according to manufacturer's instructions .
8. Do not install this product near any heat source, such as a heater, burner, or any other equipment with heat radiation .
9. Only use spare parts supplied by the manufacturer.
10. Pay attention to the safety symbol on the outside of the cover.

CONTENT

| | |
|--|---|
| INTRODUCTION | 3 |
| Features | 3 |
| Description | 3 |
| Applications | 3 |
| CONNECTION | 4 |
| Terminal Plate | 4 |
| NL4 Connection | 4 |
| System Connection Reference | 4 |
| Loudspeaker Connection | 5 |
| INSTALLATION | 6 |
| Mounting Accessories | 6 |
| Installation Reference | 6 |
| TECHNICAL SPECIFICATION | 7 |
| Technical Sheet | 7 |
| Frequency Response And Impedance Curve | 7 |
| 2D Dimension | 8 |

TW215

Dual 15" Two Way Full Range Passive Speaker

Features

- 3-transducer 2-way Full Range Speaker.
- Dual 15" High Power LF Driver.
- One 75mm HF Driver.
- Computer aided design to optimize frequency and phase response.
- Frequency Response 45Hz - 18kHz (-3dB).
- Sensitivity 101dB, MAX. SPL 128dB/134dB(PEAK).
- Rated Power 500W(RMS), 2000W(PEAK).
- US patented all-weather Paint and with dry paint technology, the hardness is 30% more than regular polyester paint.



Description

β₃ TW215 is two way wide-dispersion full range speaker adopts the new structure and patented horn design.

It integrates dual 15" woofer and one 75mm compression driver. The voice coil in the woofer uses the round copper-clad aluminium wire of inside and outside wrap technology, the TIL backbone enhances the heat dissipation of the voice coil and improves the power handling of the woofer too. Symmetrical magnet circuit design reduces the odd-order harmonic distortion to lower level. The 75mm flat voice coil in the compression driver develops the magnetic energy product efficiently to both enhance the intensity of the voice coil and increase the power handling. The rated power reaches to 500W, short term Max. power reaches to 2000W.

Cabinet is made of birch plywood with advanced environmental protection Polyurethane-based painting which is very rigid. The strength of cabinet itself reaches to 4500N. Each suspension point can bare 3000N. Q235 grille with powder coating provides strong ultra weather resistance, which can be used outdoors for 5 years. The backside foam of grille prevents the getting in of the rain.

Applications

- Church
- Auditorium
- Small Performance
- Multifunctional Hall
- Medium Conference Room

Two NL4 connectors are available for amplifier connections. Paralleled connector is very convenient for another speaker connection.

Terminal Plate

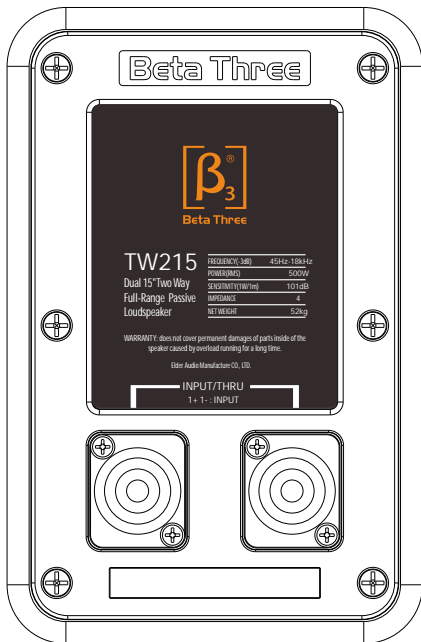

1+ 1- INPUT

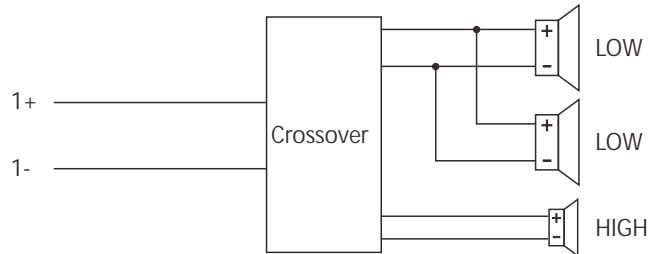

NL4 Connection

1. Connect

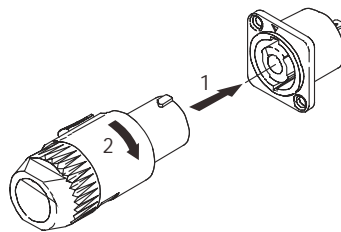

2. Disconnect

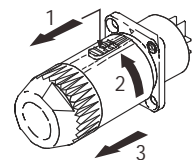

System Connection Reference

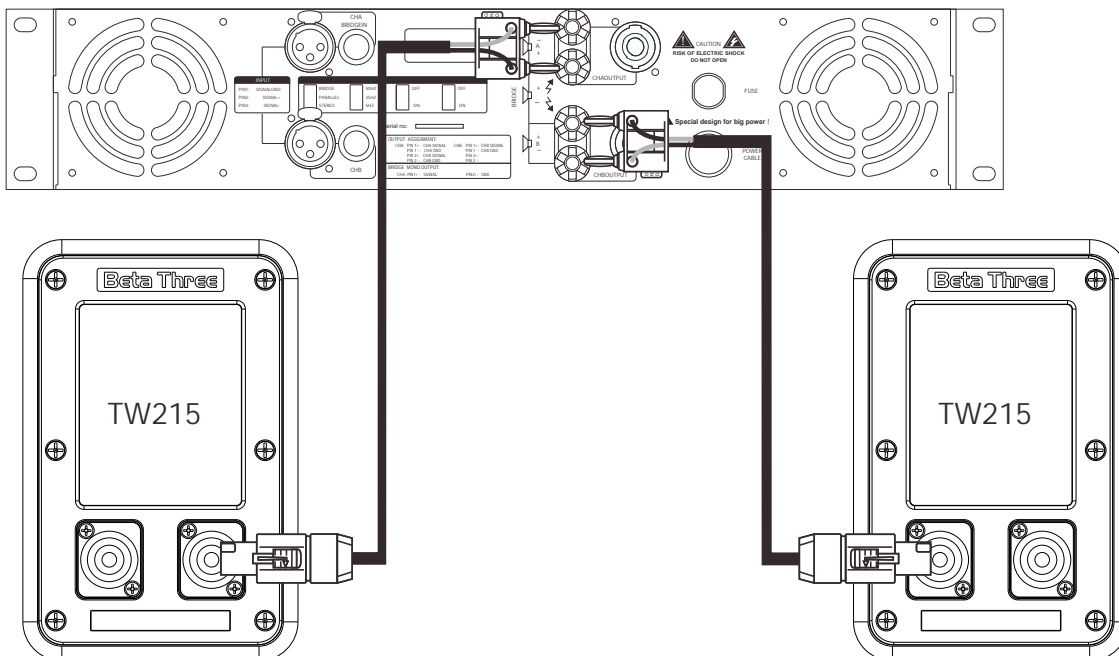

- Attention: The impedance of connected speaker must match the impedance of amplifier output.
- Attention: Make sure the polarity of speaker and amplifier are correct .

Loudspeaker Connection

1. Banana plugs to NL4

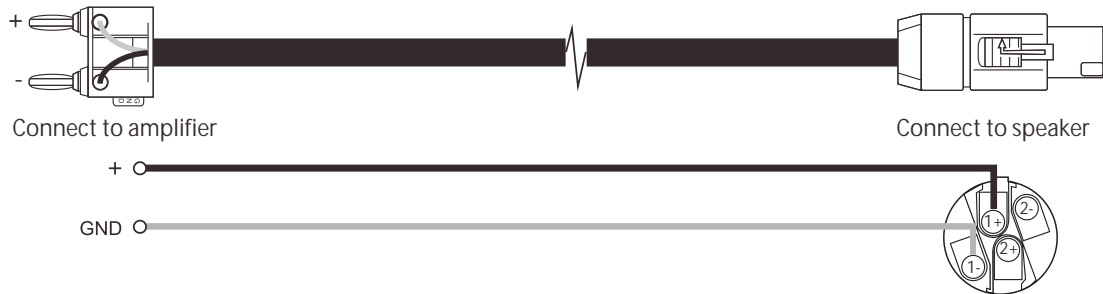

2. NL4 to NL4

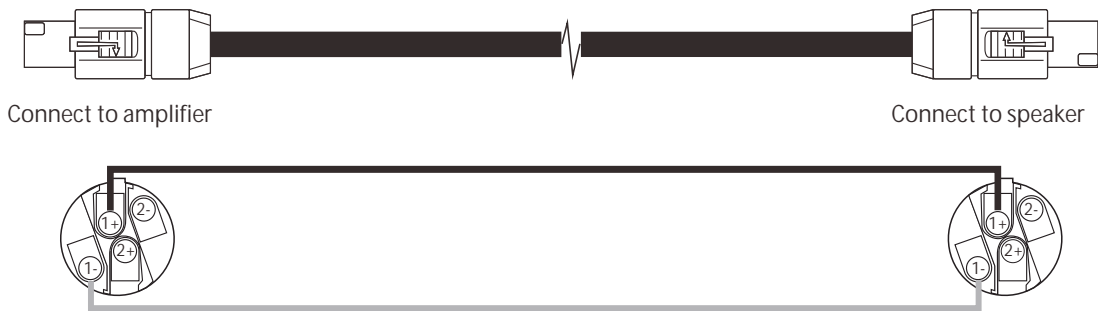

3. Consumption curve of connection cable(Only for reference, the result is different if adopting the different cables)

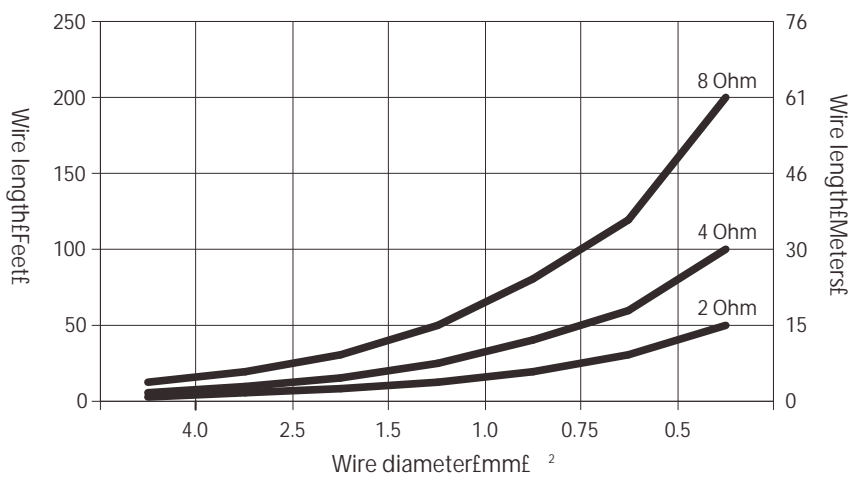

Mounting Accessories(Optional)

The standard flying mounting hardware is very convenient for different installation and applications.

1. Mobile Caster

- Caster: 100 *34mm 2 pcs
- Screws: M8 *30 Hexagon 8 pcs
- Spring washers: 8 (Black) 8 pcs
- Flat pad: 8 (Black) 8 pcs
- PE bag: 2 pcs
- Carton: 1 pc

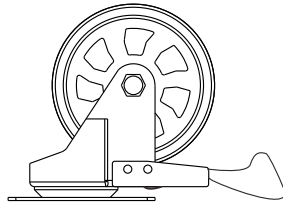

Transportation reference

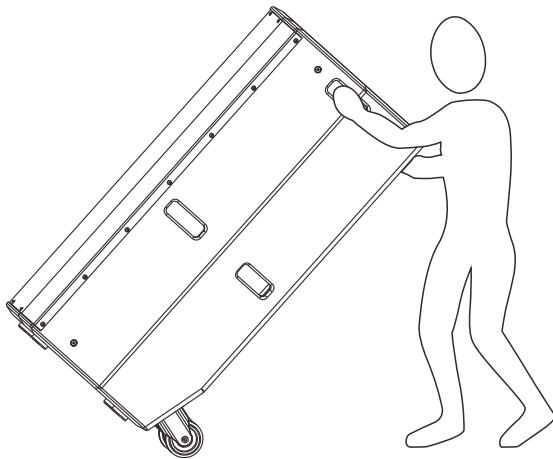

Installation Reference

1. Vertical flying mounting installation:

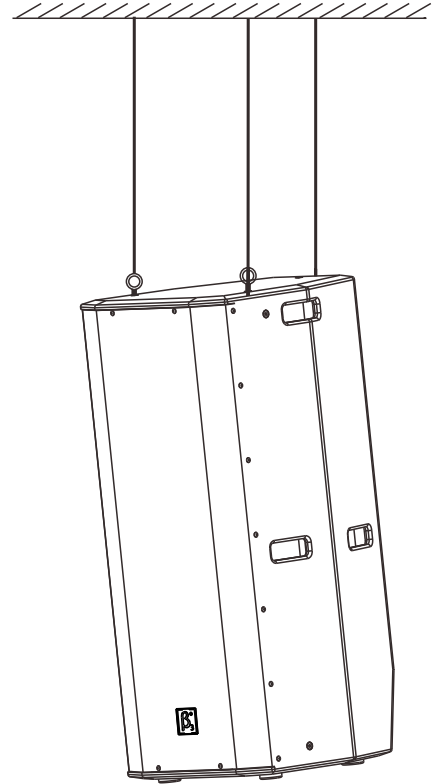

⚠ Warning: Make sure the mounting accessories safety factor not less than 5:1 or meet the local standard during installation .

Specification

| | |
|--|---|
| System: | Passive full range wooden speaker with painting |
| Tweeter: | 1 x 3" Compression Driver |
| Woofer: | 2 x 15" Woofers |
| Frequency response(-3dB): ¹ | 45Hz-18kHz |
| Frequency response(-10dB): | 40Hz-20kHz |
| Sensitivity(1W@1m): ² | 101dB |
| Max.SPL(1m): ³ | 128dB/134dB(PEAK) |
| Power: | 500W (RMS) ⁴ 1000W (MUSIC) 2000W (PEAK) |
| Dispersion(H x V): | 50° x 55 ° |
| Rated impedance: | 4 Ohms |
| Crossover point: | 1.6kHz |
| Cabinet: | Trapezoidal box, Plywood |
| Mounting accessories: | Three-point lifting |
| Handle: | 6 x Wooden handles |
| Painting: | Cabinet coated by Polyurethane paint; grille is powder coated |
| Connector: | XRL/TRS |
| Cabinet dimension: (W x D x H) | 520 x 520 x 1090mm (20.5 x 20.5 x 42.9in) |
| Package dimension: (W x D x H) | 650 x 650 x 1240mm (25.6 x 25.6 x 48.8in) |
| N.W.(pc): | 52.0kg(114.4 lb) |
| G.W.(pc): | 59.5kg(130.9 lb) |
| Optional mounting accessories: | Mobile Caster |

Speaker Testing Method

1. Frequency Response

Use Pink noise to test the speaker in the anechoic chamber, adjust the level to make the speaker work at its rated impedance and set the output power at 1W, then test the frequency response 1m away from the speaker.

2. Sensitivity

Use full range Pink noise which has been modified using an EQ curve to test the speaker in the anechoic chamber, increasing the signal to make the speaker work at its rated impedance and set the power output at 1W, then test the sensitivity 1m away from the speaker.

3. MAX.SPL

Use full range Pink noise which has been modified using an EQ curve to test the speaker in the anechoic chamber, increase the signal to make the speaker work at its maximum power output level, then test the SPL 1m away from the speaker.

4. Rated Power

Use Pink noise to the IEC#268-5 standard to test the speaker, increase the signal for a continuous period of 100 hours, the rated power is the power when the speaker will show no visible or measurable damage.

Frequency response curve & Impedance curve

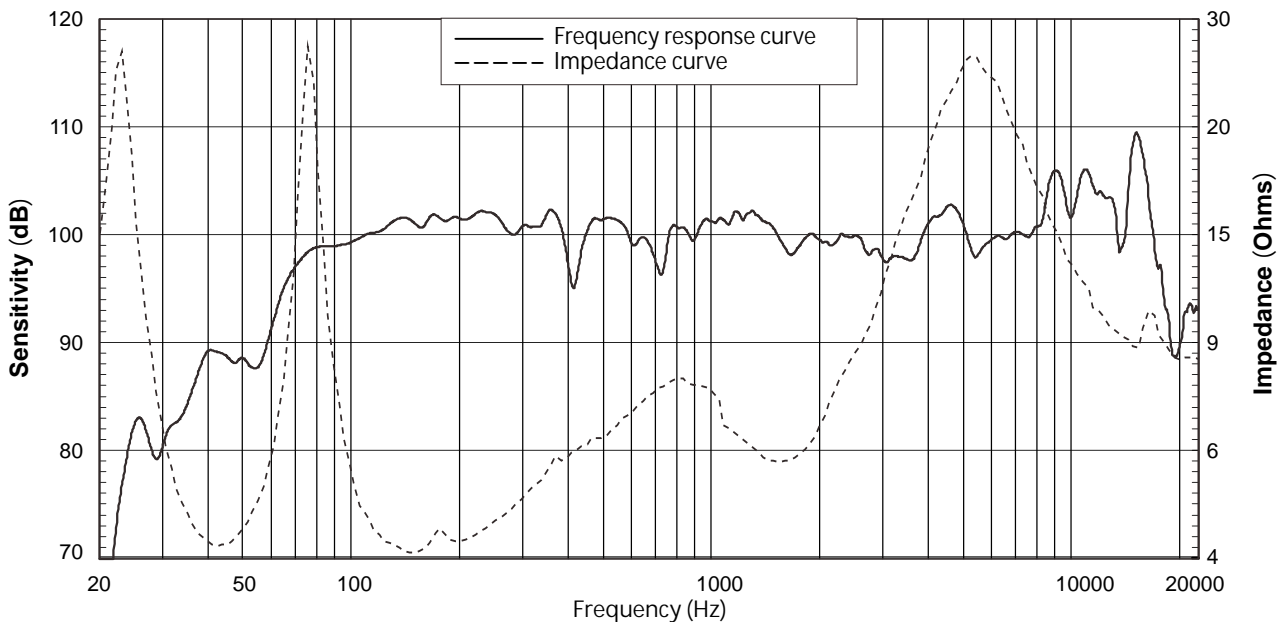

2D Dimension

Top view

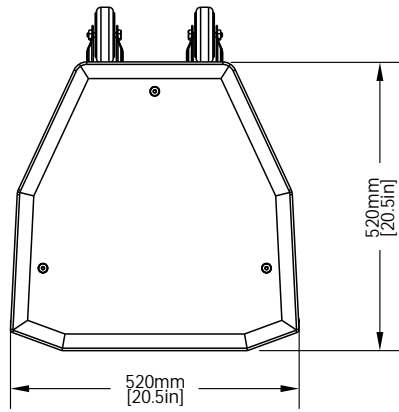

Side view

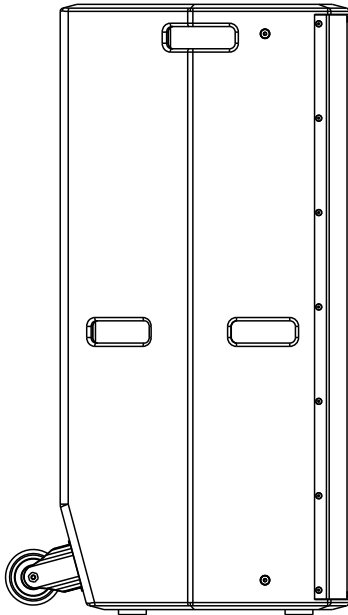

Front view

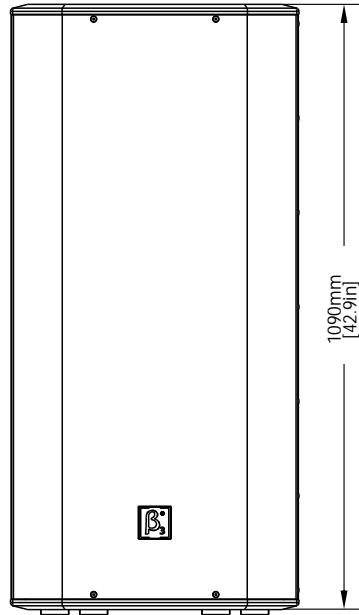

Back view

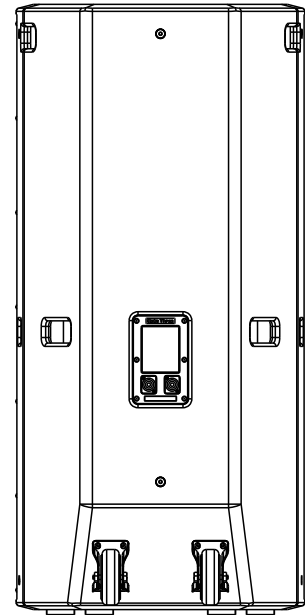

Bottom view

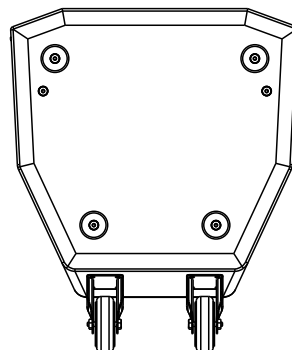

Notes:



Beta Three